COSMED does not assume any liability for end user interpretation of this user manual or for casual or consequential damages in connection with the provision, representation or use of this documentation.

No parts of this manual may be reproduced or transmitted in any form without the expressed written permission of COSMED Srl.

Each copy of the COSMED Software can only be installed on one computer.

Excel is a registered trademark of Microsoft Corporation.

DBIII is a registered trademark of Bordland International Inc.

Lotus 123 is a registered trademark of Lotus Development Corporation .

**Quark b² User manual, XVIII Edition
05/2008**

Copyright © 1999 COSMED

Copyright © 2003 COSMED

COSMED Srl - Italy

<http://www.cosmed.it>

Part N. C00827-02-91

Table of contents

Getting started	12
Important notices	13
Intended use	13
Warnings	13
Contraindication	15
Contraindications for the Spirometer tests	15
Absolute contraindications.....	15
Relative contraindications.....	15
Contraindications for Bronchial provocation tests.....	15
Absolute contraindications.....	15
Relative contraindications.....	15
Contraindications for Exercise testing	15
Environmental condition of use	16
EMC	17
Safety and conformity	20
Safety	20
EMC.....	20
Quality Assurance.....	20
Medical Device Directive (CE mark)	20
Keynotes	21
Typographic keynotes.....	21
Graphic keynotes.....	21
System overview	22
Main features.....	22
Flowmeter	22
Gas analysers.....	22
Environmental conditions measurements.....	22
Before starting	23
Checking the packing contents.....	23
Quark b ² standard packaging	23
Warranty registration	24
Register the product via software	24
How to contact COSMED	24
Complain, feedback and suggestions.....	24
Options/Accessories	25
PC configuration required	26
Technical features	27
Flowmeter	27
Oxygen Sensor (O ₂)	27
Carbon Dioxide Sensor (CO ₂).....	27
Humidity absorber	27
Power Supply.....	27

Environmental Sensors	27
Dimension and Weight	27
Aux inputs.....	27

Measurements	28
---------------------	-----------

Pulmonary function tests and measured parameters	29
Breath by Breath exercise testing.....	29
Indirect Calorimetry	29
Lactate Threshold (V-Slope).....	29
O2 Kinetics	30
Spirometry Tests (option)	30
FVC - Forced Vital Capacity	30
VC/IVC - Slow Vital Capacity and Ventilatory pattern	30
MVV - Maximum Voluntary Ventilation.....	31
Bronchoprovocation Response	31

Installation	32
---------------------	-----------

Unpacking the system.....	33
Setting up the system	34
Calibration Gas Cylinder	34
Gas pressure adjustment procedure.....	34
Connecting cables and tubing.....	35
Cables and Tubing installation sequence	36
Assemble the turbine	37
Assemble the mask and the flowmeter	37
Using the "Ultimate Seal"	37
Apply the seal to the mask.....	38
To remove seal on mask	38
Assembling the flowmeter for spirometry tests	38
Cardiac Output Module.....	39
Connecting PC	39
Software installation	40
Installing the software.....	40
Run the software	40
PC port configuration.....	40
Software main features.....	41
Display	41
Tool bar.....	41
Show/hide the toolbar	41
Dialog windows	41
Use of the keyboard.....	41
Use of the mouse	41
Scroll bars	41
On line help.....	41
Software version	41

Calibration	42
--------------------	-----------

Calibrating sensors.....	43
Running the Calibration program.....	43
Log file.....	43
Setting reference values	43
To set the reference values.....	43
Calibrating analysers.....	44
Print the calibration report	44
Edit the calibration factors	44
Turbine calibration	45
The calibration syringe	45
Turbine calibration for ergospirometry tests.....	45
Assembling the flowmeter	45
Calibrating the turbine	46
Turbine calibration for the RMR test.....	47
Assembling the flowmeter	47
Calibrate the turbine.....	47
Checking the system signals.....	48
The control panel	48
Using the control panel.....	48

Database Management	50
Exercise testing patient's database	51
Enter a new patient.....	51
Find a patient.....	51
Edit patient data	51
Delete a patient.....	51
Archive maintenance	52
Reorganise the archive	52
Delete the archive.....	52
Delete a test.....	52
Backup and restore.....	52
Backup	52
Restore	52
Spirometry patient's database.....	53
Patient Card.....	53
Visit Card.....	53
Test Card.....	54
Import/export a Tests card	54
Diagnosis Database	54
Spirometry program settings.....	55
Graphs.....	55
Serial port.....	55
Units of measurements.....	55
Using extra fields	55
Customise the fields.....	55

Exercise testing	56
-------------------------	-----------

Recommendations for the exercise testing	57
The evaluation of the cardiorespiratory function	57
Precautions	57
Laboratory	57
Ending the test	57
Preparing the patient	57
Before testing	57
Patient assent	58
Ending the test	58
Start Testing	59
Start a test	59
Abort the test without saving data	59
End the test saving data	59
View data in real-time	59
View graphs in real-time	60
Parameters to view	60
Manual protocol	60
Enter Load and Phase	60
Set the markers	60
Automatic protocol	60
Modify the load during the test	60
Set the BPM alarm	60
Enter the BPM	60
Data management	61
Viewing data	61
View data in table form	61
Creating graphs	61
View data in graph form	61
Customise the graphs	62
Switch from graph to data and vice versa	62
Viewing predicted values	63
View predicted values	63
Anaerobic (Lactate) Threshold detection	63
View the Lactate Threshold	63
Detect the Lactate Threshold	63
Customise graphs for the LT viewing	63
Fittings	64
Fit a graph with a linear regression	64
Fit a graph with a Mono-exponential regression	64
Calculate the "Mean Value"	65
Oxygen Kinetic	65
Run the O2 Kinetic function	65
Information about the Test	66
View the Information	66
Modify the information	66
Summary	66

View the summary	66
Print the data	66
Print the current window.....	67
Print the report	67
View the report.....	67
Data Editing	68
Editing values and input numerical values	68
Data filtering	68
Using the User fields.....	69
Deleting steps.....	69
Advanced Editing	69
Restore the original test	70
Overwrite the original test	70
Customise the desktop.....	70
Customise the display colours	70
Smart edit	70
Apply the graphical noise suppression	70
Apply the threshold noise suppression	70
Customise the parameters	71
Create a new parameter.....	71
Create a new predicted parameter	71
Exporting data	72
Export a test	72
DDE with Excel	72
Creating Test Protocols	73
Create a new protocol	73
Software configuration	74
Data viewing	74
Select the parameters to view	74
Select the parameters to view during the test.....	74
Sort the parameters	74
Steady State.....	74
Customise the Steady State detection criteria	74
Printout reports.....	75
Set up the printout.....	75
Select parameters to be printed	75
Customise the printout header	75
Electronic reports (*.pdf).....	76
Print the current window.....	76
Print the customised report.....	76
Events management during exercise testing	77
Cardiac Output (option)	77
Setting up the Quark b ² for the cardiac output.....	77
Performing a Cardiac Output test	78
Flow Volume loops.....	78
Flow Volume loop during the test	78

O2, CO2 vs Time	79
O2, CO2 vs Time during the test	79
O2 Saturation (optional)	79
O2 Saturation during the test	79
Spirogram.....	79
Spirogram during the test.....	79
View the events after the test	80
Raw data.....	80
Save Raw data.....	80

Resting Metabolic Rate Test 82

Metabolism.....83

Total Metabolic Rate.....	83
Resting Metabolic Rate (RMR)	83
Importance to measure RMR	83
Measure of the rest metabolic rate with indirect calorimetry... 83	
How to perform a RMR test.....	83

Recommendations84

Resting metabolic rate test using the face mask.....	84
Resting metabolic rate test using the canopy option.....	84

Performing a test using the face mask85

Calibrations	85
How to prepare a patient	85
Start the test.....	85
Viewing the test	87
How to modify the average interval.....	87
Print.....	88

Performing a test using the canopy option.....89

Calibrations	89
How to prepare the canopy and the patient.....	89
Replacement of the power plug	89
Connecting the Canopy.....	89
How to prepare the patient.....	90
Performing the test.....	90
Viewing the test	91
How to modify the average interval.....	91
Print.....	91

Sub-maximal Exercise Testing 92

Introduction93

Pre-test screening	93
--------------------------	----

Sub-maximal exercise testing94

Considerations with sub-maximal exercise testing	94
Staffing.....	95
Test termination	95

Considerations for accuracy96

Performing the test97

An example of testing protocol	97
--------------------------------------	----

The mixing chamber	98
---------------------------	-----------

The mixing chamber	99
Overview	99
Preparing the mixing chamber for a test	99
Two-way non rebreathing valve description	99
Patient's preparation.....	100
Performing the test	100

Spirometry	102
-------------------	------------

Setting spirometry options.....	103
--	------------

Spirometry	103
Automatic Interpretation.....	103
Quality control	103
Parameters manager	104
Predicted values manager.....	104
Predicteds set	104
Set the current predicted	105
Formula definition	105
Page set-up	106

Spirometry tests	107
-------------------------------	------------

Forced Vital Capacity (pre)	108
--	------------

Recommendations	108
Perform a FVC (pre) test.....	108
Test encouragement	108
Perform the FVC test with the encouragement.....	109

Slow Vital Capacity	110
----------------------------------	------------

Perform a SVC test	110
--------------------------	-----

Maximum Voluntary Ventilation.....	111
---	------------

Perform a MVV test.....	111
-------------------------	-----

Bronchial Provocation Test	112
---	------------

Bronchodilator test.....	112
Methacholine and Histamine Bronchial provocation Tests ...	112
Perform the test	113
Bronchial Provocation protocols Database	113
Enter a new Bronchial provocation protocol in the archive.....	113

Viewing results	114
------------------------------	------------

Tests of the current patient.....	114
Delete a test.....	114

Printing results.....	115
------------------------------	------------

Printing Reports	115
Printing the active window.....	115
To print the active window	115
Printing a series of reports.....	115
Electronic reports (*.pdf)	115

Export data	116
Export a test	116

System maintenance 118

System maintenance	119
Cleaning and disinfection	119
Preparing the disinfecting solution	119
Cleaning the turbine flowmeter.....	120
Precautions during the cleaning of the turbine	120
Masks cleaning and disinfection	120
Disassembling the different parts of the mask.....	120
Cleaning the mask.....	120
Disinfecting the mask	120
Canopy bubblehood (option) cleaning.....	121
RMR reader (option) cleaning	121
Precautions during the cleaning of the turbine	121
Two-way non rebreathing valve cleaning (option)	121
Mixing chamber cleaning and disinfection (option).....	121
Permapure maintenance	121
Inspections	122
Replace the fuses.....	122
Select the proper power supply voltage	123

Appendix 124

Conformity declaration.....	125
Service - Warranty	126
Warranty and limitation of liability	126
Return goods policy for warranty or non warranty repair.....	126
Repair Service Policy.....	127
Privacy Information.....	128
Personal data treatment and purposes	128
How your personal data are treated.....	128
The consent is optional, but... ..	128
Holder of the treatment	128
Customer rights.....	128
Waste of electrical and electronic equipment.....	129
Analog - Digital auxiliary inputs.....	130
AUX RS232	130
Pin-out assignment.....	130
Handshaking protocol configuration	130
AUX1/ AUX4 analog Inputs.....	130
Enable the AUX input	130
Converting factors configuration	132
Pin-out assignment.....	132
Heart Rate – TTL input.....	133
Calculations references	134

VO ₂ and VCO ₂	134
Anaerobic threshold (modified V-Slope).....	134
O ₂ kinetics.....	134
Cardiac Output.....	134
ATS 94 recommendations	135
ATS recommendations.....	135
Predicted values	136
Automatic diagnosis (algorithm).....	137
Quality Control Messages.....	137
References.....	139
Gas Exchange References.....	139
Indirect calorimetry.....	139
Cardiac Output.....	139
Spirometry	139
Sub-maximal testing	139



Getting started

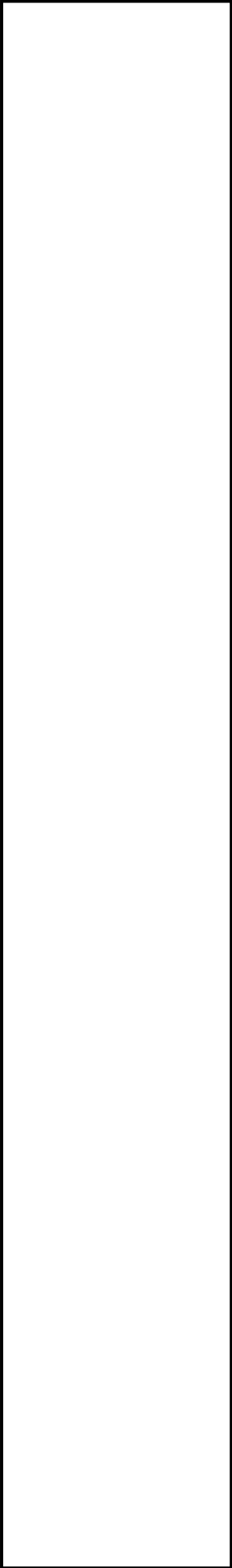

Important notices

Intended use

Quark b² is an electrical medical device designed to perform pulmonary function tests. It is to be used by physicians or by trained personnel on a physician responsibility.

Caution: Federal law restricts this device to sale by or on the order of a physician.

This equipment has been conceived with the aim of providing an auxiliary instrument allowing:

- the formulation of lung pathology diagnosis;
- important studies concerning human physiology;
- the collection of important information in sport medicine.

No responsibility attaches COSMED Srl for any accident happened after a wrong use of the device, such as:

- use by non qualified people;
- non respect of the device intended use;
- non respect of the hereunder reported precautions and instructions.

Warnings

The device, the programme algorithms and the presentation of measured data have been developed according to the specifications of ATS (American Thoracic Society) and ERS (European Respiratory Society). Other international references have been followed when these were not available. All bibliography references are reported in Appendix.

The present handbook has been developed with respect of the European Medical Device Directive requirements which sort Quark b² within Class II a.

It is recommended to read carefully the following precautions before putting the device into operation.

The precautions reported below are of fundamental importance to assure the safety of all COSMED equipment users.

1. This user manual is to be considered as a part of the medical device and should always be kept on hand.
2. Safety, measure accuracy and precision can be assured only:
 - using the accessories described in the manual or given with the device. Actually non recommended accessories can affect safety unfavourable. Before using non recommended accessories it is necessary to get in touch with the manufacturer;
 - ordinary equipment maintenance, inspections, disinfection and cleaning are performed in the way and with the frequency described;
 - any modification or fixing is carried out by qualified personnel;
 - the environmental conditions and the electrical plants where the device operates are in compliance with the specifications of the manual and the present regulations concerning electrical plants. In particular grounding reliability and leakage current suppression can only be assured when the device three – wire receptacle is connected to a yellow - green return connected to earth ground. Attempting to defeat the proper connection of the ground wire is dangerous for users and equipment.
3. Before powering the system, check the power cables and the plugs. Damaged electrical parts must be replaced immediately by authorised personnel.
4. Large gas cylinders, which may be given by the manufacturer or purchased by the customer, should be secured with cylinder safety chains or safety stands.
5. When removing the protective cap, inspect the cylinder valve for damaged threads, dirt, oil or grease. Remove any dust or dirt with a clean cloth. If oil or grease is present on the valve of a cylinder which contains oxygen, do not attempt to use. Such combustible substances in contact with oxygen are explosive.
6. Be certain that the materials of the pressure regulators are chemically compatible with the intended gas service before installation. Inspect the regulator for the proper

connection and note the ranges of the pressure gauges. Also examine the physical condition of the regulator including threads and fittings. Remove any dust or dirt from the regulator or cylinder valve with a clean cloth. Do not install a regulator on a cylinder valve containing oxygen if grease or oil is present on either. Such substances in contact with oxygen are explosive.

7. Cleaning residue, particulates, and other contaminants (including pieces of torn or broken components) in the breathing circuit pose a safety risk to the patient during testing procedures. Aspiration of contaminants can potentially be life-threatening. Use disposable anti-bacterial filters or disinfect each part in contact with the patient before each test.
8. You must follow all the cleaning procedures in System Maintenance, and you must thoroughly inspect the components after cleaning and before each patient test.
9. This device is not suitable for use in presence of flammable anaesthetics. It is not an AP nor an APG device (according to the EN 60 601-1 definitions).
10. Keep the device away from heat and flame source, flammable or inflammable liquids or gases and explosive atmospheres.
11. In accordance with their intended use Quark b² is not to be handled together with other medical devices unless it is clearly declared by the manufacturer itself.
12. It is recommended to use a computer with electromagnetic compatibility CE marking and with low radiation emission displays.
13. It is necessary to make the PC, connected to the Quark b², compliant with EN 60601-1 by means of an isolation transformer.
14. The Quark b² needs special precautions regarding EMC and needs to be installed and put into service according to the EMC information provided in the section *EMC*.
15. Portable and mobile RF communications equipment can affect the Quark b².
16. Use only the cable and accessories supplied with the equipment. The use of accessories and/or cables other than those supplied may result in increased emissions or decreased immunity of the equipment.
17. The Quark b² should not be used adjacent to or stacked with other equipment. If adjacent or stacked use is necessary, the Quark b² should be observed to verify normal operation in the configuration in which it will be used.
18. Graphical symbols used in accordance to present specifications are described here below:



Equipment type B (EN60601-1)



Equipment type BF (EN60601-1)



Danger: high temperature



OFF



ON



Protective earth ground



Alternating current

Contraindication

The physical strain to execute the respiratory manoeuvre is contraindicated in case of some symptoms or pathology. The following list is not complete and must be considered as a piece of mere information.

Contraindications for the Spirometer tests

Absolute contraindications

For FVC, VC and MVV tests:

- Post-operating state from thoracic surgery

For FVC tests:

- Severe instability of the airways (such as a destructive bronchial emphysema)
- Bronchial non-specific marked hypersensitivity
- Serious problems for the gas exchange (total or partial respiratory insufficiency)

Relative contraindications

For FVC tests:

- spontaneous post-pneumothorax state
- arterial-venous aneurysm
- strong arterial hypertension
- pregnancy with complications at the 3rd month.

For MVV test:

- hyperventilation syndrome

Contraindications for Bronchial provocation tests

The bronchial provocation tests must be executed according to the doctor's discretion. There are not data that reveal specific contraindication for the bronchial provocation test through inhalation.

The modern standard processes have been revealing secure in several clinical studies. However it is recommendable to respect the following contraindications:

Absolute contraindications

- Serious bronchial obstruction (FEV1 in adults)
- Recent myocardium infarct
- Recent vascular-cerebral accident
- Known arterial aneurysm
- Incapacity for understanding the provocation test procedures and its implications.

Relative contraindications

- Bronchial obstruction caused by the respiratory manoeuvre.
- Moderate or serious bronchial obstruction. For ex. FEV1 < 1.51 in men and FEV1 in women < than 1.21.
- Recent infection in the superior air tracts
- During the asthmatic re-acuteing
- Hypertension
- Pregnancy
- A pharmacology treatment epilepsy

Contraindications for Exercise testing

Read carefully the exercise testing chapter.

Environmental condition of use

COSMED units have been conceived for operating in medically utilised rooms without potential explosion hazards.

The units should not be installed in vicinity of x-ray equipment, motors or transformers with high installed power rating since electric or magnetic interferences may falsify the result of measurements or make them impossible. Due to this the vicinity of power lines is to be avoided as well.

Cosmed equipment are not AP not APG devices (according to EN 60601-1): they are not suitable for use in presence of flammable anaesthetic mixtures with air, oxygen or nitrogen protoxide.

If not otherwise stated in the shipping documents, Cosmed equipment have been conceived for operating under normal environmental temperatures and conditions [IEC 601-1(1988)/EN 60 601-1 (1990)].

- Temperature range 10°C (50°F) and 40°C (104°F).
- Relative humidity range 20% to 80%
- Atmospheric Pressure range 700 to 1060 mBar
- Avoid to use it in presence of noxious fumes or dusty environment and near heat sources.
- Do not place near heat sources.
- Cardiopulmonary resuscitation emergency equipment accessible.
- Adequate floor space to assure access to the patient during exercise testing.
- Adequate ventilation in the room.

Guidance and manufacturer's declaration - electromagnetic emissions		
The Quark b ² is intended for use in the electromagnetic environment specified below. The customer or the user of the Quark b ² should assure that it is used in such an environment.		
Emissions test	Compliance	Electromagnetic environment - guidance
RF emissions CISPR 11	Group 1	The Quark b ² uses RF energy only for its internal function. Therefore, its RF emissions are very low and are not likely to cause any interference in nearby electronic equipment.
RF emissions CISPR 11	Class B	The Quark b ² is suitable for use in all establishments, including domestic establishments and those directly connected to the public low-voltage power supply network that supplies buildings used for domestic purposes.
Harmonic Emission IEC 61000-3-2	Class A	
Voltage Fluctuations / Flicker Emission IEC 61000-3-3	Complies	

Guidance and manufacturer's declaration - electromagnetic immunity			
The Quark b ² is intended for use in the electromagnetic environment specified below. The customer or the user of the Quark b ² should assure that it is used in such an environment.			
Immunity test	Test level	Compliance level	Electromagnetic environment - guidance
Electrostatic discharge (ESD) IEC 61000-4-2	±6 kV contact ±8 kV air	±6 kV contact ±8 kV air	Floors should be wood, concrete or ceramic tile. If floors are covered with synthetic material, the relative humidity should be at least 30%.
Electrical fast transient/burst IEC 61000-4-4	±2 kV for power supply lines ±1 kV for input/output lines	±2 kV for power supply lines ±1 kV for input/output lines	Mains power quality should be that of a typical commercial or hospital environment.
Surge IEC 61000-4-5	±1 kV differential mode ±2 kV common mode	±1 kV differential mode ±2 kV common mode	Mains power quality should be that of a typical commercial or hospital environment.
Voltage dips, short interruptions and voltage variations on power supply input lines IEC 61000-4-11	<5% U _T (>95% dip in U _T) for 0.5 cycles 40% U _T (60% dip in U _T) for 5 cycles 70% U _T (30% dip in U _T) for 25 cycles <5% U _T (>95% dip in U _T) for 5 sec	<5% U _T (>95% dip in U _T) for 0.5 cycles 40% U _T (60% dip in U _T) for 5 cycles 70% U _T (30% dip in U _T) for 25 cycles <5% U _T (>95% dip in U _T) for 5 sec	Mains power quality should be that of a typical commercial or hospital environment. If the user of the Quark b ² requires continued operation during power mains interruptions, it is recommended that the Quark b ² be powered from an uninterruptible power supply or a battery.
Power frequency (50/60 Hz) magnetic field IEC 61000-4-8	3 A/m	3 A/m	Power frequency magnetic fields should be at levels characteristic of a typical location in a typical commercial or hospital environment.
Note: U _T is the a.c. mains voltage prior to application of the test level.			

Guidance and manufacturer's declaration - electromagnetic immunity			
The Quark b ² is intended for use in the electromagnetic environment specified below. The customer or the user of the Quark b ² should assure that it is used in such an environment.			
Immunity test	Test level	Compliance level	Electromagnetic environment - guidance
<p>Conducted RF IEC 61000-4-6</p> <p>Radiated RF IEC 61000-4-3</p>	<p>3 V_{eff} 150 kHz to 80 MHz</p> <p>3 V/m 80 MHz to 2.5 GHz</p>	<p>3 V</p> <p>3 V/m</p>	<p>Portable and mobile RF communications equipment should be used no closer to any part of the Quark b², including cables, than the recommended separation distance calculated from the equation applicable to the frequency of the transmitter</p> <p>Recommended separation distance</p> $d=1.17\sqrt{P}$ <p>d=1.17 \sqrt{P} 80 MHz to 800 MHz</p> $d=2.33\sqrt{P}$ <p>d=2.33 \sqrt{P} 800 MHz to 2.5 GHz</p> <p>where <i>P</i> is the maximum output power rating of the transmitter in watts (W) according to the transmitter manufacturer and <i>d</i> is the recommended separation distance in metres (m).</p> <p>Field strengths from fixed RF transmitters, as determined by an electromagnetic site survey^a, should be less than the compliance level in each frequency range^b.</p> <p>Interference may occur in the vicinity of equipment marked with the following symbol:</p> 
<p>Notes:</p> <p>(1) At 80 MHz, the higher frequency range applies.</p> <p>(2) These guidelines may not apply in all situations. Electromagnetic propagation is affected by absorption and reflection from structures, objects and people.</p> <p>a Field strengths from fixed transmitters, such as base stations for radio (cellular/cordless) telephones and land mobile radios, amateur radio, AM and FM radio broadcast and TV broadcast cannot be predicted theoretically with accuracy. To assess the electromagnetic environment due to fixed RF transmitters, an electromagnetic site survey should be considered. If the measured field strength in the location in which the Quark b² is used exceeds the applicable RF compliance level above, the Quark b² should be observed to verify normal operation. If abnormal performance is observed, additional measures may be necessary, such as reorienting or relocating the Quark b².</p> <p>b Over the frequency range 150 kHz to 80 MHz, field strengths should be less than 3 V/m.</p>			

Recommended separation distances between portable and mobile RF communications equipment and the Quark b²

The Quark b² is intended for use in an environment in which radiated RF disturbances are controlled. The customer or the user of the Quark b² can help prevent electromagnetic interference by maintaining a minimum distance between portable and mobile RF communications equipment (transmitters) and the Quark b² as recommended below, according to the maximum output power of the communications equipment..

Rated maximum output power of transmitter (W)	Separation distance according to frequency of transmitter (m)		
	150 kHz to 80 MHz $d=1.17\sqrt{P}$	80 MHz to 800 MHz $d=1.17\sqrt{P}$	800 MHz to 2.5 GHz $d=2.33\sqrt{P}$
0.01	0.12	0.12	0.23
0.1	0.37	0.37	0.74
1	1.17	1.17	2.33
10	3.70	3.70	7.38
100	11.70	11.70	23.33

For transmitters rated at a maximum output power not listed above, the recommended separation distance d in metres (m) can be determined using the equation applicable to the frequency of the transmitter, where P is the maximum output power rating of the transmitter in watts (W) according to the transmitter manufacturer.

Notes:

- (1) At 80 MHz and 800 MHz, the separation distance for the higher frequency range applies.
- (2) These guidelines may not apply in all situations. Electromagnetic propagation is affected by absorption and reflection from structures, objects and people.

Safety and conformity

Safety

IEC 601-1 (1988) /EN 60 601-1 (1990);

Find reported below the complete classification of the device:

- Class I type B device
- Protection against water penetration: IP00, ordinary equipment unprotected against water penetration
- Non sterile device
- Device not suitable in the presence of flammable anaesthetics;
- Continuous functioning equipment;

EMC

The system meets the EMC Directive 89/336

EN 60601-1-2

EN 55011 Class B (emission), IEC 1000-4-2, IEC 1000-4-3, IEC 1000-4-4

Quality Assurance

UNI EN ISO 9001:2000 (Registration n° 387-A Cermet)

UNI EN ISO 13485:2003 (Registration n° 387-M Cermet)

Medical Device Directive (CE mark)

MDD 93/42/EEC (Notified Body 0476).

Class IIa

Keynotes

Here are the keynotes used to make the manual easier to read.

Typographic keynotes

These are the typographic keynotes used in the manual.

Style	Description
Bold	indicates a control or a key to be pressed.
<i>“Italic”</i>	indicates a messages shown by the firmware.

Graphic keynotes

These are the graphic keynotes used in the manual.

Illustration	Description
	shows the button to click in the software to activate the related feature.

System overview

Main features

The Quark b² unit contains the main items (analysers, electronic controls, valves...). It is connected to the PC through an RS232 interface. The modular architecture allows to replace the boards without any other technical service.

The unit can be used on a desktop or on the optional trolley, ideal for the Quark b², the cylinders, the PC, the printer...

Flowmeter

The system uses a bi-directional digital turbine. It opposes a very low resistance to flow (<0,7 cmH₂O/l/s to 12 l/s). The air passing through the helical conveyors, takes a spiral motion which causes the rotation of the turbine rotor. The rolling blade interrupts the infrared light beamed by the three diodes of the optoelectronic reader. Every interruption represents 1/6 turn of the rotor, this allows to measure the number of turn in the time.

Gas analysers

The O₂ and CO₂ analysers are temperature-controlled and the internal pressure and expired flow are monitored for an higher reliability if the measurements.

The Quark b² uses Nafion Permapure ® which is a semipermeable capillary tube capable of removing the humidity in excess without altering the gas concentrations..

The analysers calibration is automatic and shows both graphically and numerically the flow and concentration signals and the accuracy of the baseline/gain.

Environmental conditions measurements

The Barometric pressure is measured by an electronic pressure sensor inside the unit. It has a measuring range between 400 mmHg and 800 mmHg. Ambient temperature and relative humidity are measured by two sensors contained in the RH/TA probe. The above measurements are used to calculate BTPS and STPD correction factors.

Before starting

Before operating the Quark b² system we strongly recommend to check the equipment and register you as a customer.

Checking the packing contents

Make sure that the package contains the items listed below. In case of missing or damaged parts, please contact Cosmed technical assistance.

Quark b² standard packaging

Code	Qty	Description
C00930-01-04	1	Quark b ² ergo unit
C02120-01-05	2	Turbine Ø 28mm
C02170-01-11	1	Kit optoelectronic reader Quark ergometry
A 800 900 001	2	Head cap for the adult masks
C00243-01-06	1	Calibration Syringe 3L
C02210-02-08	1	Permapure L2m
C01399-02-12	1	Cable in HR TTL
C02910-01-10	1	Mask mouth/nose breath adult S
C02911-01-10	1	Mask mouth/nose breath adult M
C02912-01-10	1	Mask mouth/nose breath adult L
C00861-01-06	1	HR probe
A 661 200 001	1	HR elastic belt
A 661 200 002	1	HR polar transmitter
A 182 310 001	5	Anti moisture filter
C01804-02-11	1	Calibration tube
C01348-01-06	1	External RH/TA probe
A 388 010 004	1	Filtered serial adapter
A 362 060 001	1	Power cord Schuko 2m
A 362 300 001	1	RS232 cable DB9 M/F
A 680 013 630	2	Time lag fuses 5x20 250V T630mA
A 680 024 125	2	Time lag fuses 5x20 250V T1,25A
C01790-01-36	1	PC software
C01999-01-DC	1	Conformity declaration
C00067-02-94	1	Registration card
C01340-02-91	1	Quark b ² User Manual

Warranty registration

Before using the system, please take a moment to fill in the registration form and the warranty and return them to COSMED, by doing this you are eligible to the customers assistance service.

For further information, please refer to the enclosed registration and warranty form. If the form is not enclosed in the packaging, please contact directly COSMED.

Register the product via software

Together with the PC software, a registration software is supplied. With this software it is possible to fill in an electronic form with the customer information.

1. To run the software, double click on the icon **Registration** or select **Registration...** from ? menu.
2. Type the requested information and click **Send...** to send the form via e-mail to COSMED.

How to contact COSMED

For any information you may need, please contact the manufacturer directly at the following address:

COSMED S.r.l.
Via dei Piani di Monte Savello, 37
P.O. Box n. 3
00040 - Pavona di Albano
Rome - ITALY
Voice: +39 (06) 931.5492
Fax: +39 (06) 931.4580
email: customersupport@cosmed.it
Internet: <http://www.cosmed.it>

Complain, feedback and suggestions

If you have any complain, feedback information or suggestion, please inform us at complain@cosmed.it.

Options/Accessories

The following options are available to enhance or to complete the Quark b² system:

Code	Quantity	Description
A 860 000 004	1	Calibration cylinder (5% CO ₂ , 16% O ₂ , balance N ₂)
C01500-01-04	1	Trolley for Quark PFT
C01700-01-04	1	Trolley with arm for Quark PFT
A 870 150 001	1	Pressure regulator for calibration cylinder
C00689-01-30	1	Mask mouth/nose breath ID28 adult XL
C01278-01-30	1	Mask mouth/nose breath ID28 paediatric L
C01277-01-30	1	Mask mouth/nose breath ID28 paediatric S
A 800 900 004	1	Paediatric Headcap
C01396-01-11	1	Oxymeter
C01234-01-11	1	Heart rate monitor
C01402-01-11	1	Cardiac output
C02150-01-11	1	Spirometry
C01380-01-12	1	Extension oxymeter cable
A 180 015 001	1	Silica gel 500g

PC configuration required

- Pentium II 350 MHz.
- Windows XP, Vista
- 64 Mb RAM .
- CD drive.
- VGA, SVGA monitor.
- Serial Port RS 232 available (2 serial ports in case of Ergometer control). An USB port can replace one RS232 serial port, if using the USB-RS232 adaptor (Cosmed code A 388 410 001).
- Any Mouse and Printer compatible with the MS Windows™ operative system.
- PC conform to European Directive 89/336 EMC

Technical features

Flowmeter

Type:	Bidirectional digital turbine Ø 28 mm
Flow Range:	0,03-20 L/sec
Accuracy:	± 2%
Resistance:	<0.7 cmH ₂ O s/L @ 12 L/s
Ventilation Range:	0-300 litres x min

Oxygen Sensor (O₂)

Type	Zirconia temperature controlled
Response time:	<120 ms
Range:	1-100% O ₂
Accuracy:	±0.01% O ₂

Carbon Dioxide Sensor (CO₂)

Type:	NDIR
Response time:	<120 ms
Range:	0-15%
Accuracy:	±0.03%

Humidity absorber

Capillary of Nafion (Permapure ®)

Power Supply

Voltage:	100V-240V ±10%; 50/60Hz
Power consumption	100W

Environmental Sensors

Temperature:	0-50°C
Barometer:	400-800 mmHg
Humidity:	0-100%

Dimension and Weight

Dimensions:	17x30x45 cm
Weight:	8 Kg

Aux inputs

Eight analog inputs (0-5, 0-10 Volts) for external measurement (HR, Pressure, ...). Digital (TTL) input for external ECG signal. Auxiliary RS 232 port for ergometers control (cicloergometers, treadmill...).

Measurements

--

Pulmonary function tests and measured parameters

Breath by Breath exercise testing

Symbol	UM	Parameter
VO ₂	ml/min	Oxygen Uptake
VCO ₂	ml/min	Carbon Dioxide production
V _t	l	Tidal Volume
F _{et} O ₂	%	End Tidal O ₂
F _{et} CO ₂	%	End Tidal CO ₂
R	---	Respiratory Quotient
VE	l/min	Ventilation
HR	1/min	Heart Rate
Q _t	l	Cardiac output
AT	---	Anaerobic Threshold
VE	l/min	Ventilation
SV	l/min	Stroke volume
RF	1/min	Respiratory Frequency
FeO ₂ , FeCO ₂	%	Averaged expiratory concentration of O ₂ e CO
VE/VO ₂	---	ventilatory equivalent for O ₂
VE/VCO ₂	---	ventilatory equivalent for CO ₂
VO ₂ /HR	ml/beat	Oxygen pulse
VO ₂ /Kg	ml/min/Kg	VO ₂ per Kg
T _i , T _e , T _i /T _{tot}	sec	time breaths
V _d /V _t	---	V _d /V _t ratio
PaCO ₂	mmHg	arterial PCO ₂ (estimated)
P(a-et)CO ₂	mmHg	Delta PaCO ₂ – PetCO ₂

Indirect Calorimetry

Symbol	UM	Parameter
EE	Kcal/day	Energy Expenditure
EE/BSA	Kcal/day/m ²	Energy Expenditure/Body surface area
EE/Kg	Kcal/day/Kg	Energy Expenditure pro Kg
FAT	Kcal/day	Fats
CHO	Kcal/day	Carbohydrate
PRO	Kcal/day	Protein
FAT%	%	% Fat
CHO%	%	% Carbohydrate
PRO%	%	% Protein
npRQ	---	Respiratory quotient not protein

Lactate Threshold (V-Slope)

Symbol	UM	Description
VO ₂ @ LT	l/m	Lactate (Anaerobic) Threshold STPD
R @ LT	--	Respiratory Quotient @ LT
Time @ LT	hh:mm:ss	Time @ LT
VCO ₂	ml/min	CO ₂ output @ LT STPD
VE	l/min	Ventilation @ LT BTPS

HR	bpm	Heart Rate @ LT
----	-----	-----------------

O2 Kinetics

Parameter	UM	Calculation
O ₂ deficit	l/m	VO ₂ @work*tau
O ₂ debt	l/m	VO ₂ '@work*tau

Spirometry Tests (option)

FVC - Forced Vital Capacity

Symbol	UM	Parameter
FVC	l	Forced Expiratory Vital Capacity
FEV1	l	Forced Expiratory Volume in 1 sec
FEV1/FVC%	%	FEV1 as a percentage of FVC
PEF	l/sec	Peak Expiratory Flow
FEV0.5	l	Forced Expiratory Volume in 0.5 sec
FEV6	l	Forced Expiratory Volume in 6 sec
FEV1/FEV6	%	FEV1 as a percentage of FEV6
FEV6/FVC%	%	FEV6 as a percentage of FVC
Best FVC	l	Best Forced Expiratory Vital Capacity
Best FEV1	l	Best Forced Expiratory Volume in 1 sec
Best PEF	l/sec	Best Peak Expiratory Flow
Vmax25%	l/sec	Expiratory Flow when 75% of the FVC remains to be exhaled
Vmax50%	l/sec	Expiratory Flow when 50% of the FVC remains to be exhaled
Vmax75%	l/sec	Expiratory Flow when 25% of the FVC remains to be exhaled
FEF25-75%	l/sec	Mid-exp flow between 25-75%FVC
FET100%	sec	Forced expiratory time
FEV2	l	Forced Expiratory Volume in 2 sec
FEV3	l	Forced Expiratory Volume in 3 sec
FEV2/FVC%	%	FEV2 as a percentage of FVC
FEV3/FVC%	%	FEV3 as a percentage of FVC
FEV1/VC%	%	Tiffenau index
FEF50-75%	l/sec	Mid-exp flow between 50-75%FVC
FEF75-85%	l/sec	Mid-exp flow between 75-85%FVC
FEF0.2-1.2%	l/sec	Mid-exp flow between 0.2 l - 1.2 l
FiVC	L	Inspiratory Forced Vital Capacity
FiF25-75%	l/sec	Forced mid-inspiratory flow
FiV1	l/sec	Forced Inspiratory Volume in 1 sec
PIF	l/sec	Peak Inspiratory Flow
VEXT	ml	Extrapolated Volume (back extrapolation)
PEFT	msec	Time to PEF (10% - 90%)

VC/IVC - Slow Vital Capacity and Ventilatory pattern

Symbol	UM	Parameter
EVC	l	Expiratory Vital Capacity
IVC	l	Inspiratory Vital Capacity
ERV	l	Expiratory Reserve Volume
IRV	l	Inspiratory Reserve Volume
IC	l	Inspiratory Capacity

VE	l/min	Expiratory Minute Ventilation
Vt	l	Tidal Volume
Rf	1/min	Respiratory Frequency
Ti	sec	Duration of Inspiration
Te	sec	Duration of Expiration
Ttot	sec	Duration of Total breathing cycle
Ti/Ttot	—	Ti/Ttot ratio
Vt/ti	l/sec	Vt/ti ratio

MVV - Maximum Voluntary Ventilation

Symbol	UM	Parameter
MVV	l/min	Maximum Voluntary Ventilation
MVt	l	Tidal Volume (during MVV)
MRf	1/min	Maximum Respiratory frequency
MVVt	sec	MVV duration time

Bronchoprovocation Response

Symbol	UM	Parameter
FallFEV1	%	Fall in FEV1 from baseline or post diluent
FallVmax50%	%	Fall in Vmax50% from baseline or post diluent
P10	—	Provocative dose causing FEV1 to fall 10% from baseline
P15	—	Provocative dose causing FEV1 to fall 15% from baseline
P20	—	Provocative dose causing FEV1 to fall 20% from baseline

Installation

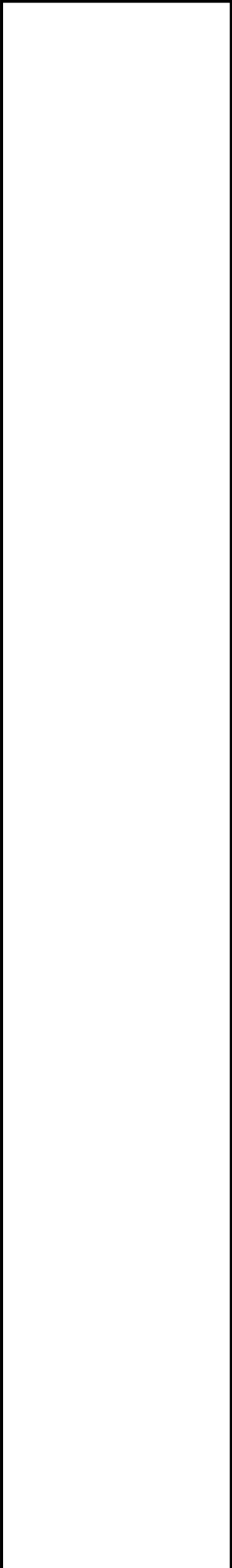

Unpacking the system

On receipt of your system, you should immediately inspect your package for shipping damages, in case damage is suspected please contact the reseller immediately. Your system has to be installed by COSMED or by an authorised reseller.

Excessive amount of dust and miscellaneous clutter around the instrument can eventually cause malfunctions due to overheating of components, we strongly suggest to keep the unit in a clean environment and well ventilated as possible. Quark b² and accessories can have place on the trolley as shown in the following illustration.

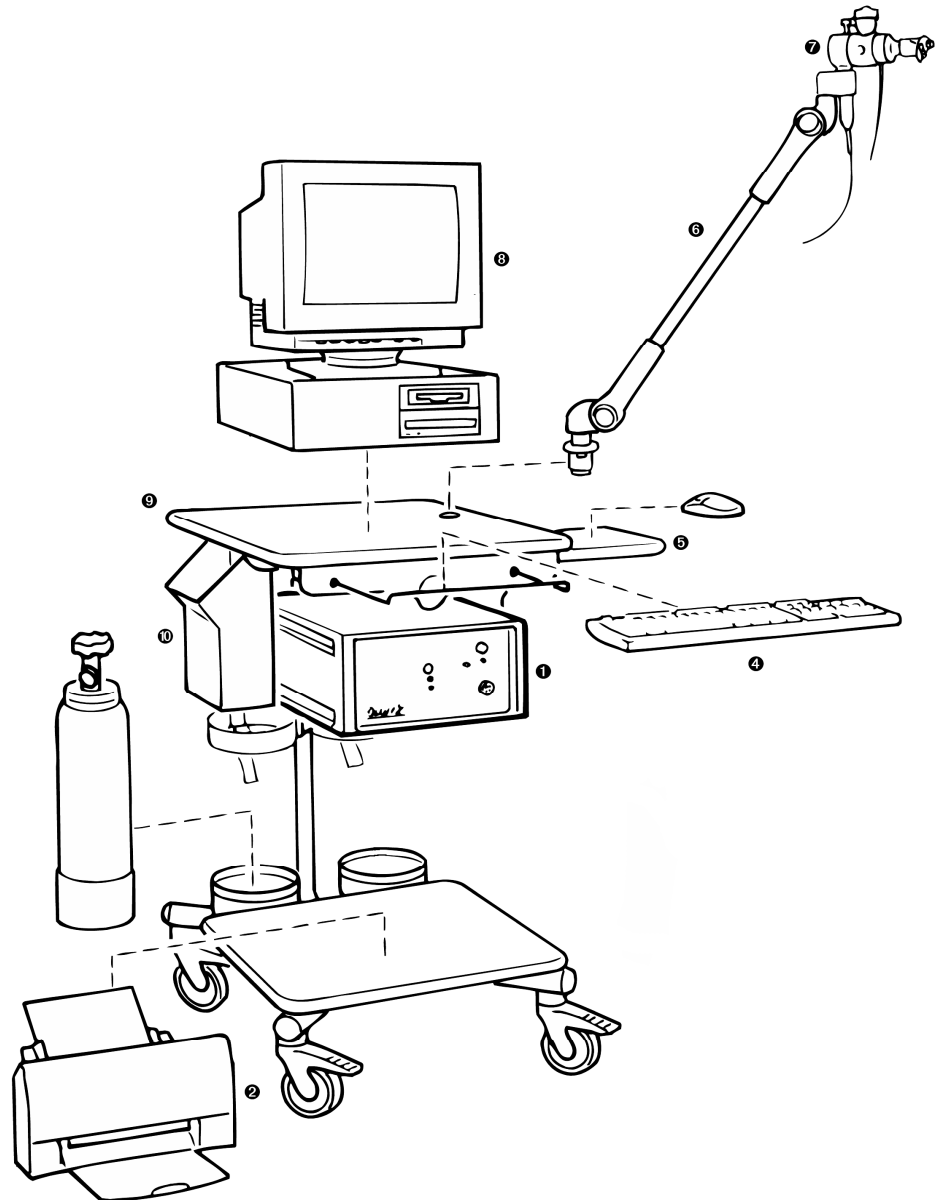

1. Quark unit
2. Printer
3. Calibration cylinder
4. Keyboard
5. Mouse pad
6. Table arm
7. Breathing valve
8. PC
9. Trolley
10. Bag

Setting up the system

Before starting operating with the system make sure to meet the environmental and operational conditions reported in Chapter 1.

Calibration Gas Cylinder

In order to calibrate the sensors you need to have available calibration cylinder with the following gas concentration:

Cylinder	Recommended Gas mixture
Calibration	O ₂ 16%, CO ₂ 5%, N ₂ Bal

Gas pressure adjustment procedure

The gas regulator has an adjustable second stage that must be adjusted only when used for the first time. This is necessary to protect the internal demand valve from the high pressure surge that can be generated when the cylinder is opened.

1. Make sure that the regulator is turned off before opening the cylinder valve.
2. Open the cylinder valve by turning the valve counter-clockwise.
3. Adjust the regulator pressure by turning the adjustment knob clockwise in order to reach a value between 5 and 6 atmospheres (bar).



Notice: The cylinders must be provided with a calibration certificate, indicating the gas composition.

Notice: The gas cylinder must be replaced when the primary pressure gauge falls below 10 bar.

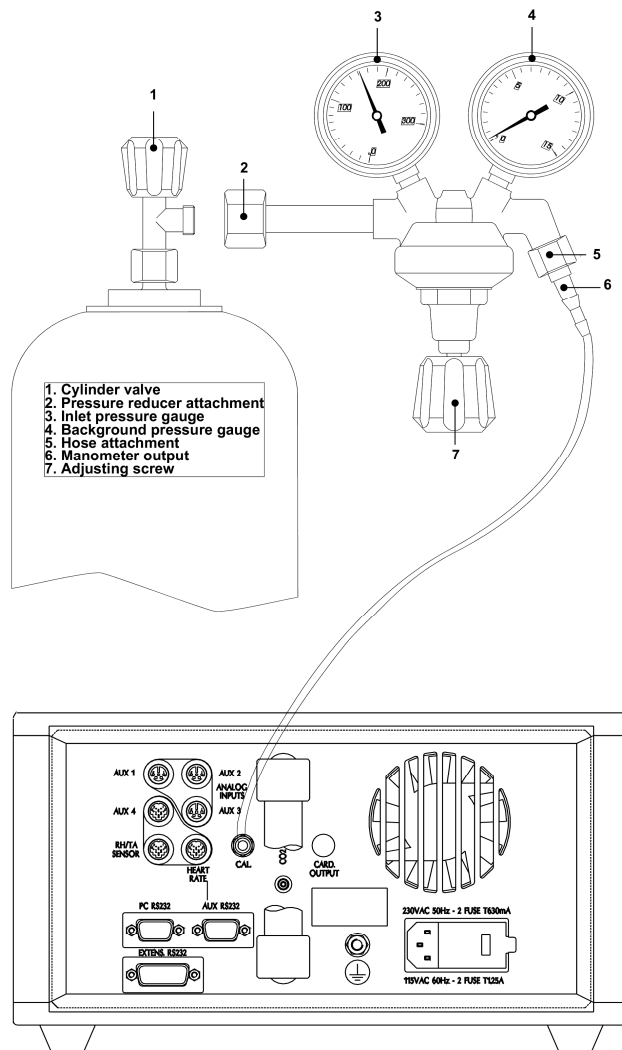

Connecting cables and tubing

The assembling procedure will be shown in the following illustrations.

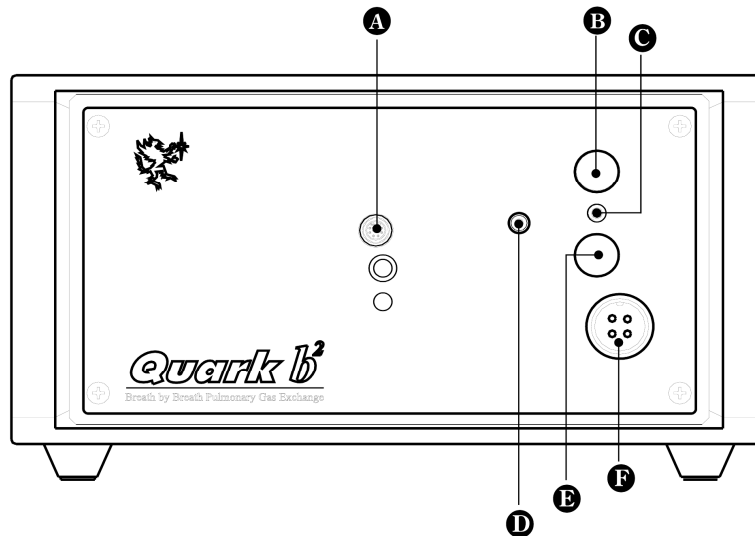

- A Flowmeter connector
- B Power switch
- C Sampling tube connector
- D Calibration plug
- E Oxymeter plug
- F Cardiac Output plug

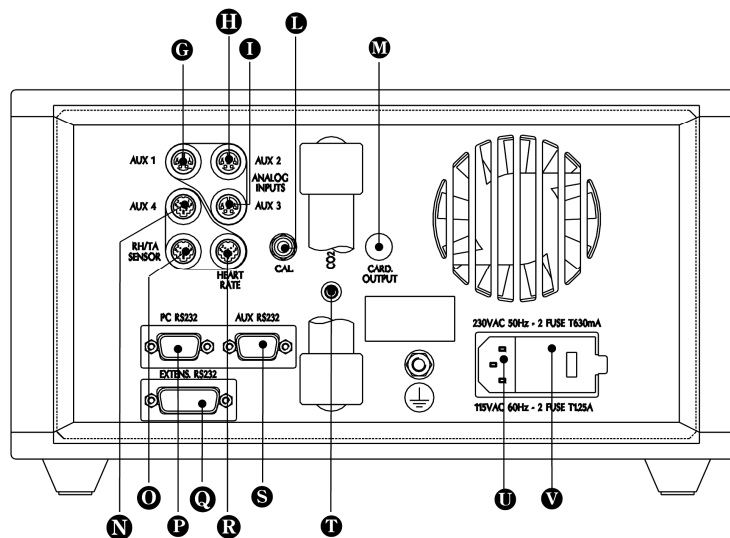

- G, H, I, N Auxiliary analog inputs
- L Calibration gas (16% O₂, 5% CO₂) connector
- M Cardiac Output gas connector
- O RH/TA probe connector
- P RS232 Serial Port for PC connection
- Q RS232 (for future extensions)
- R HR probe connector
- S RS232 Serial Port for ergometer connection
- T Sampling pump input
- U Power cable connector
- V Switch 110V / 220V

Cables and Tubing installation sequence

1. Connect the power cable of the Quark b² to the trolley
2. Connect the power cable of the PC and the printer to the trolley
3. Connect the RS232 cable from the Quark b² (PC RS232) to the PC (COM1 or COM2). If the PC does not have a RS232 port, please use the USB-RS232 adapter (A 388 410 001), available as an accessory.
4. Connect the O₂-CO₂ calibration cylinder to the Quark b² and adjust its pressure between 5 and 6 bar.
5. Connect the Flowmeter to the front panel of the Quark.

Assemble the turbine

Assemble the mask and the flowmeter

1. Insert the turbine in the optoelectronic reader, in the way indicated by the arrow in the turbine.
2. Insert the turbine plug on the front panel.

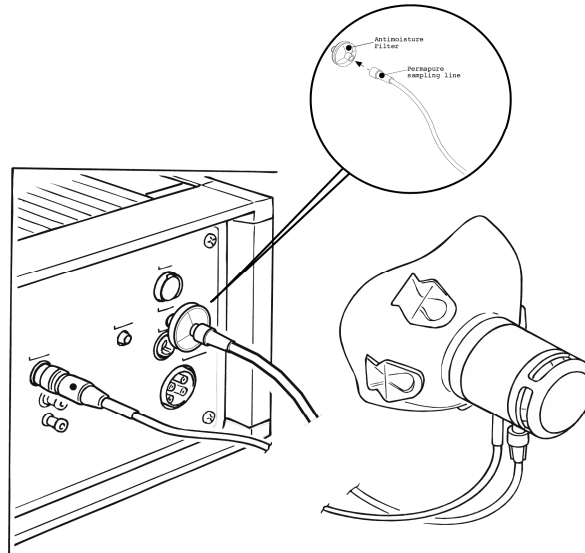

Notice: It is advisable to lubricate periodically the O-rings inside the optoelectronic reader with silicone grease for its good maintenance.

3. Connect the external anti moisture filter to the sampling plug and joint the Permapure sampling line to the filter. It's strongly suggest to use the filter always and we recommend to replace it every 3 months.

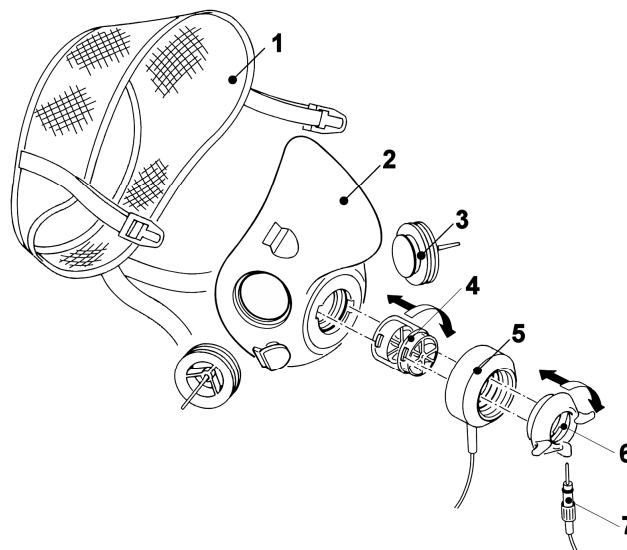

1. Headcap
2. Mask
3. Inspiratory valve
4. Turbine
5. Optoelectronic reader
6. Sampling adapter
7. Sampling plug

Using the "Ultimate Seal"

The "ultimate seal" is a moulded of Elasto-Gel, a glycerine based hydrogel. This product is a unique polymer gel that forms an intimate seal between the face and the mask. It has to be used for mask applications on hard to seal faces and where leaks are not tolerated.

- Will not irritate the skin
- Contains no adhesives.
- Has no odour
- Will not dry out
- Single patient use

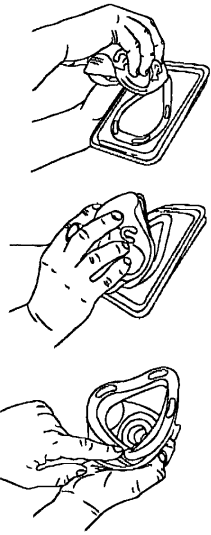

Apply the seal to the mask

Apply seal to clean, residue-free mask only and follow the instructions below:

1. Remove the plastic tray from the bag. Peel off clear film and retain for later use.
2. While holding tray align the nose area of mask to nose area of Ultimate Seal™ gel. Press together and roll mask down over the surface of the gel seal attaching it to the mask and releasing it from the tray.
3. If needed, adjust the position of the seal, aligning it with the outer perimeter of the mask sealing surface.
4. The mask is now ready to be placed on the subject's face.

To remove seal on mask

- The Ultimate Seal™ have been conceived for a single patient use only, it can not be cleaned or sterilised.
- If mask requires cleaning for a new patient application then pull off and dispose of the Ultimate Seal™.
- To keep the seal clean between use, keep it attached to the mask and place the clear film against the Ultimate Seal™ gel on the mask. When the seal becomes discoloured or opaque (approximately two weeks) dispose of the current seal and replace it with a new one.



Notice: Avoid the exposure to the sun. Do not put the seal into the water.

Assembling the flowmeter for spirometry tests

In case the spirometry kit option is purchased assemble the turbine as shown in the illustration below.

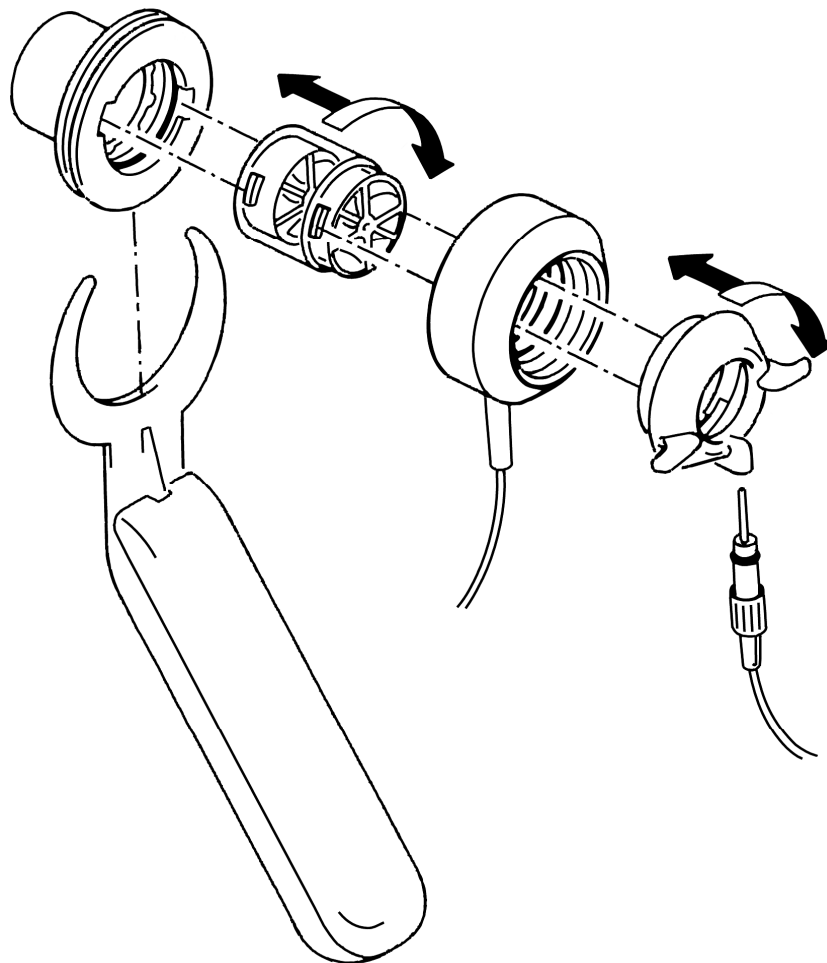

Cardiac Output Module

The Cardiac Output Module is provided with the Cardiac Output option and it consists of a special valve together with a bag that has to be filled in with a different gas concentration (see Chapter 6 for further information).

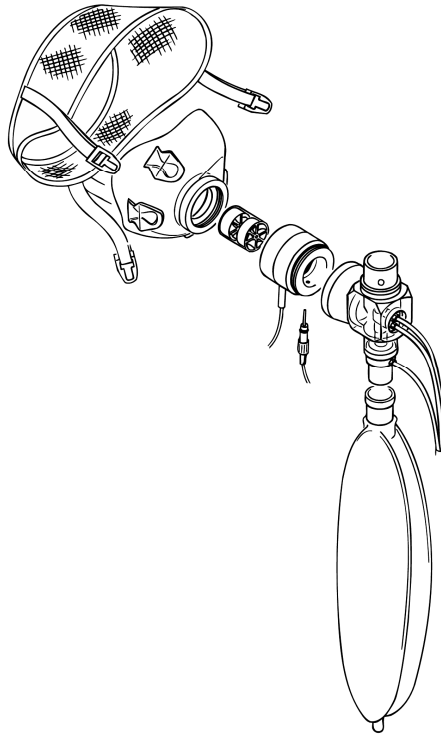

Connecting PC

Before operating the system make sure the unit is connected to the PC as described in the following illustration:

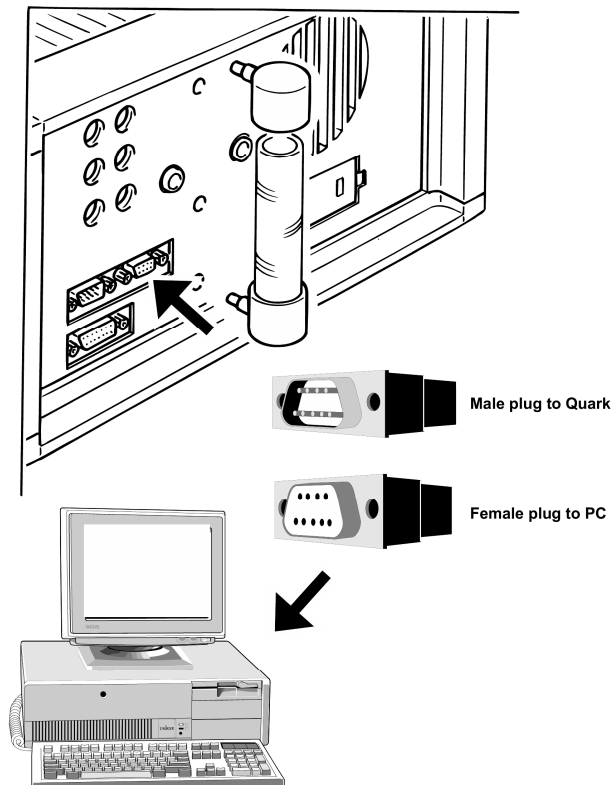

Software installation

Note: The software can be installed on Windows XP or Vista. It will not work on any previous versions of Windows.

The software consists of two programs: a spirometry program (uses a green CD, labelled PFT, option) and the program for ergometry (uses a blue CD, labelled CPET). The programs share the same archive and system calibration program.

One or both software programs may need to be installed depending on the device configuration.

Installing the software

Note: The software is copyright protected and should be installed only from the original disk.

1. Insert the installation CD into the CD-ROM drive.
2. The installation will begin automatically. If the disc does not start automatically you will need to run Setup.exe.
3. Follow the instructions given by the dialog boxes to complete the installation.
4. When the installation is finished, the program will alert you that the installation has been successfully completed.

Note: If both programs are installed, the directory for the CPET software should be the same as the PFT directory (default is C:\PFTSUITE).

Run the software

1. In the Windows **Start** menu, open the Program Group in which the software was installed.
2. Click the **CPET** or the **PFTSuite** icon.

PC port configuration

The first time the software is used, it is necessary to configure the communication port with the PC (USB, COM1, COM2,...).

For further details, see the chapter *Database management*.

Software main features

Display

The program may contain several windows. The active window is highlighted with a different colour of the caption. Some functions of the program are "active window" sensitive (Print, right key of the mouse).

Tool bar

Many of the functions that may be selected from the menu can be activated more rapidly by clicking with the mouse on the corresponding icon in the tool bar.

Positioning the mouse cursor on one of the buttons of the toolbar (if the option Hints is enabled), the description of the corresponding function is shown in a label.

Show/hide the toolbar

Select **Toolbar** from **Options** menu in order to show or hide the toolbar.

Dialog windows

The typical operating environment of Microsoft Windows is the Dialog box. This window is provided with a series of fields in which input the information.

Use of the keyboard

- To move the cursor among fields, press the **Tab** key until you reach the desired field.
- Press the **Enter** key to confirm the information input on the dialog box or press the **Esc** key to cancel changes.

Use of the mouse

- To move the cursor among fields, move the mouse on the desired field and left-click.
- Click on the **OK** button with the Left button of the mouse to confirm the information input on the dialog box or click on **Cancel** button to cancel changes.

Scroll bars

Some windows are provided with scroll bars that help to see data exceeding the window space available.

- To move the scroll bar row by row click the scroll arrows at the end of the scroll bars
- To move the scroll bar page by page click on the grey area at both sides of the scroll fields

On line help

COSMED Quark Help is a complete on-line reference tool that you can use at any time. Help is especially useful when you need information quickly or when the Quark user manual is not available. Help contains a description of each command and dialog box, and explains many procedures for accomplishing common tasks.

To get the Help on line, press the **F1** key.

Software version

To know the software version and the serial number of the software, select **About Quark b²...** from **Help** menu.

Calibration

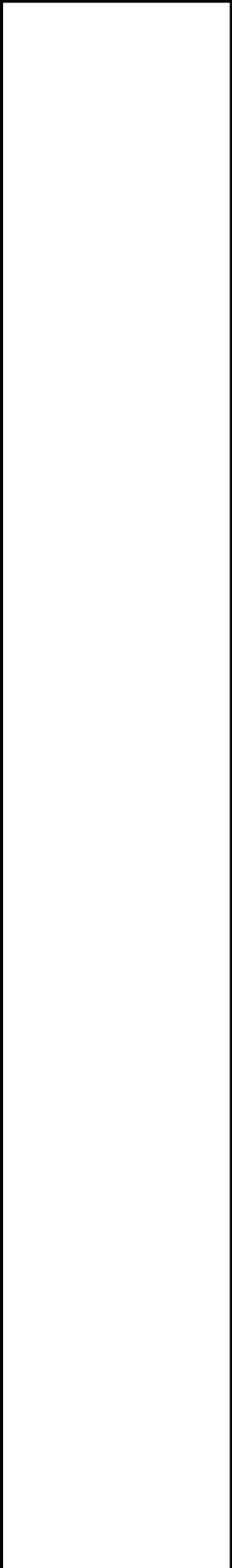

Calibrating sensors

The software allows to automatically calibrate zero, gain and delay of gas sensors. Even if the program doesn't force you to carry out the calibration we strongly recommend to execute it before each test.

Running the Calibration program



Start the program and choose **Calibration** from the **Test** Menu. The software runs the Calibration software and the main menu changes accordingly.

Log file

The program creates and updates as default the calibration log file, containing the conditions and the results of all the calibrations performed by the user.

To access the file select **File/Report File...** from the calibration program.

Setting reference values

Before starting calibrating make sure that the system has been configured correctly by setting the right values of gas concentration of: room air (i.e. 20.95% O₂ and 0.03% CO₂), of gas mixture contained in the cylinders and the volume of the calibration syringe (i.e. 3 litres).

To set the reference values

This operation must be performed only the first time. The next times, the system keeps stored the reference values entered in this step.

1. Select **Reference Values** from the **Calibration** menu.
2. Type the correct values for the O₂ and CO₂ room air concentration (i.e. 2093 for 20.93%), and do the same for the gas concentration of the calibration cylinder.

Section	Parameter	Value
Cylinders (%x100)	O2:	1604
	CO2:	502
Environment (%x100)	O2:	2093
	CO2:	3
Syringe (ml)	Volume:	3000

3. Type the volume of the calibration syringe (i.e. 3000 for a 3 litres calibration syringe).
4. Press **OK** button to confirm changes.

Calibrating analysers



Note: After turning on the unit, wait 30 minutes warm up time before starting the calibration procedure.

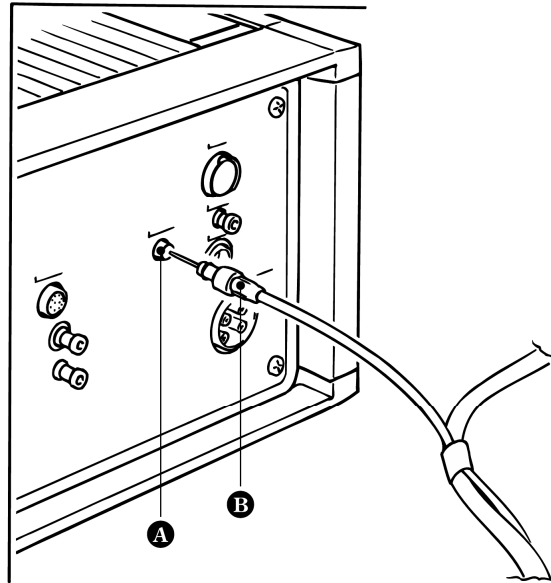

This calibration must be repeated at least daily. A new calibration before any ergospirometry test is strongly recommended.

1. Remove the sampling line from the flowmeter.
2. Ensure that the O₂-CO₂ cylinder is properly connected to the rear panel of the Quark b² and check that the pressure of the gas is in the range 5-6 bar.
3. Check if the reference values for the calibration gas specified in **File/Reference values...** correspond to the certified composition of the mixture.
4. Connect the sampling line to the CAL port placed on the front panel of the Quark b².
5. Select **Calibration/Gas.../Gas...** and wait until the procedure is completed.

The software performs automatically the calibration procedure. After 90 seconds the graph will be displayed. In this way, the user can check the calibration procedure both graphically and numerically.

At the end of the procedure, the software displays the new calibration factors vs. the old ones.

Print the calibration report

In the Calibration program choose **Print** from the **File** menu.

Edit the calibration factors

The last sensors calibration factors can be either edited or viewed. To do this choose **Gas Results...** from the **File** menu.

To view or edit the last Turbine calibration factor choose **Turbine results...** from the **File** menu.

Note: To restore factory setting press **Default** button in the dialog box. Once you press the default button you must run a new calibration before testing.

Turbine calibration

The system uses a turbine flowmeter. It opposes a very low resistance to flow (<0,7 cmH₂O/l/s to 12 l/s). The air passing through the helical conveyors, takes a spiral motion which causes the rotation of the turbine rotor.

The rolling blade interrupts the infrared light beamed by the three diodes of the optoelectronic reader. Every interruption represents 1/6 turn of the rotor, this allows to measure the number of turn in the time. There is a constant ratio between air passing through the turbine and number of turns. This allows an accurate measure of flows and volume. The turbine flowmeter doesn't need daily calibrations as it is not affected by pressure, humidity and temperature.

To work properly, the turbine only requires the rotor to rotate freely without any friction that might be caused by dust that can be easily avoided with an ordinary cleaning procedure (see Maintenance).

However in order to ensure accuracy it's recommended to run periodically the calibration procedure. Calibration has to be carried out with a calibration syringe of 3 litres volume, the calibration procedure is totally managed by software.

A measurement system should be calibrated daily in order to ensure maximum accuracy and reliable test results. If a correct maintenance is provided it's possible to check the calibration of the turbine flowmeter even at relatively long intervals (i.e. 1 month). The calibration procedure assures valid and verifiable results within a $\pm 3\%$ accuracy.

The calibration syringe

The 3 litres calibrated syringe is included in all the Quark PFT line with the exclusion of the PFT 1 model.

3 litres calibration syringe: P/N C00600-01-11.

Turbine calibration for ergospirometry tests

Before starting the calibration procedure, be sure that the turbine type is properly selected (in the calibration program, select **File/Turbine results...**, in the field *Type (mm)* must be entered 28).

Actual		Acceptable Range	
Type (mm):	28	Gain Exp.:	900:1100
Gain Exp.:	1000	Gain Ins.:	900:1100
Gain Ins.:	1000		

Buttons: OK, Cancel, Factory Settings, Help

Assembling the flowmeter

1. Connect the Opto-reader to the calibration syringe through the adapter.
2. Connect the flowmeter to the syringe with the rubber cylinder supplied in the standard packaging.

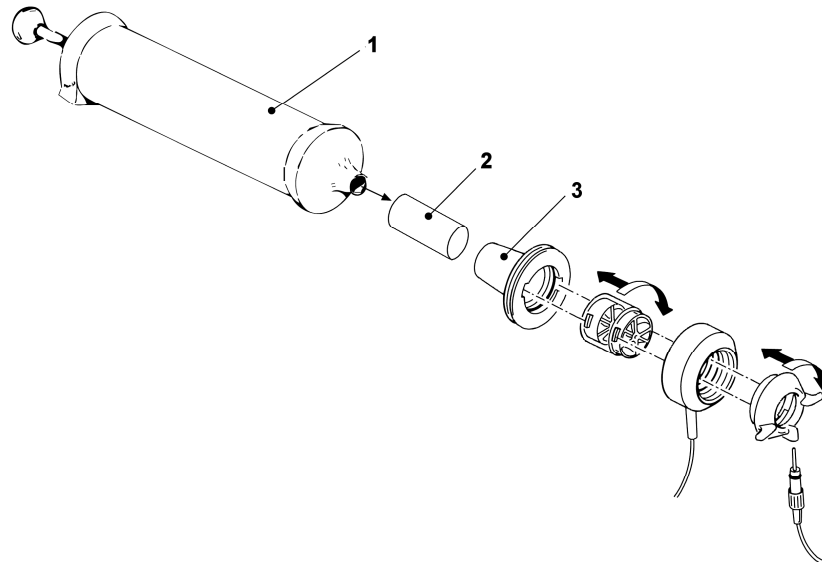

1. Syringe
2. Silicone tube
3. Adaptor for calibration syringe.

Note: If a bacterial filter is used for the tests, do use it also during the turbine calibration.

Calibrating the turbine

After having run the calibration program:

1. Select **Reference Values** from the **File** menu. If your syringe has a different value from the default one (3 litres), please enter the correct value.
2. Select **Calibration/Turbine...**
3. When the **Calibration Turbine** dialog box appears with the syringe piston initially pushed all the way in, move the piston in and out for 5 inspiratory strokes and 5 expiratory strokes in order to get the first values appearing on the display. Then move the syringe piston for other 10 strokes (IN and EX).



Note: if you are using a slow PC, we recommend to set an higher refresh time

Turbine Calibration ✕

Syringe volume: 3000 ml

Results					
Exp.	%	Gain	Ins.	%	Gain
3002	+0.07	1046	2993	-0.23	1027
2985	-0.50	1048	2995	-0.17	1028
2972	-0.93	1052	3010	+0.33	1026
2993	-0.23	1052	2993	-0.23	1027
3019	+0.63	1051	2984	-0.53	1027
2992	-0.27	1051	2990	-0.33	1028
2994	-0.20	1051	3004	+0.13	1027
3009	+0.30	1050	3008	+0.27	1027
2988	-0.40	1051	2996	-0.13	1027
2374	-0.87	1051	3006	+0.20	1027

Move the calibration syringe...

4. At each of the 10 steps the software displays the results of the manoeuvre and the percentage error in the reading.
5. At the end of this operation, the software displays the new calibration factors. Press **OK** to store the new value.

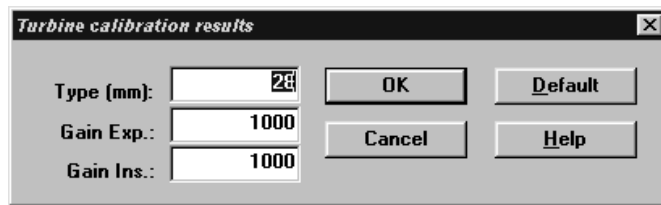

Turbine calibration for the RMR test

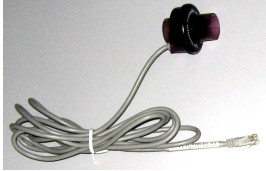

The turbine used for resting metabolic rate tests is different from the standard one (used for ergo-spirometric tests). Since the correction factors for the two turbines are different, before using this turbine, it is necessary to select and calibrate the turbine used.

In the calibration program, select **File/Turbine results...**, and enter 18 in the field *Type (mm)*.

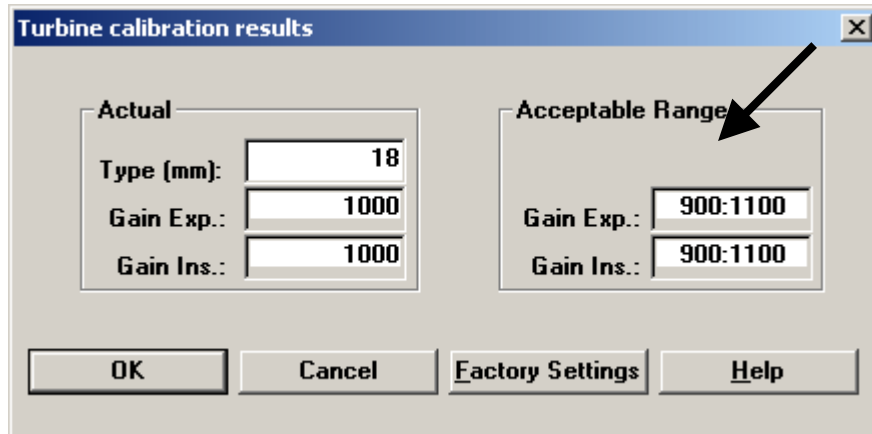

At the end of the RMR tests, before starting using the standard turbine, set 28 in the *Type(mm)* field and perform a turbine calibration with the standard turbine.



Assembling the flowmeter

Connect the RMR reader to the syringe by means of the proper adaptor.

Calibrate the turbine

Perform a turbine calibration according to the procedure described above. Since the ventilation is very low (normally <10 litres/min), the turbine calibration has to be performed with very slow manoeuvres (each complete manoeuvre in about 10-15 seconds), to obtain the best accuracy.

Checking the system signals

The control panel

The **Control Panel**, which can be activated from the **Calibration/Control panel...** menu item, is a useful tool to check the main hardware functions of Quark b².

By using the controls on Control Panel you are able to do the following:

1. Reading the signals acquired by the system both as voltages and processed data;
2. Activating/Disactivating the valves, the sampling pump and other installed components (for example, oxymeter).

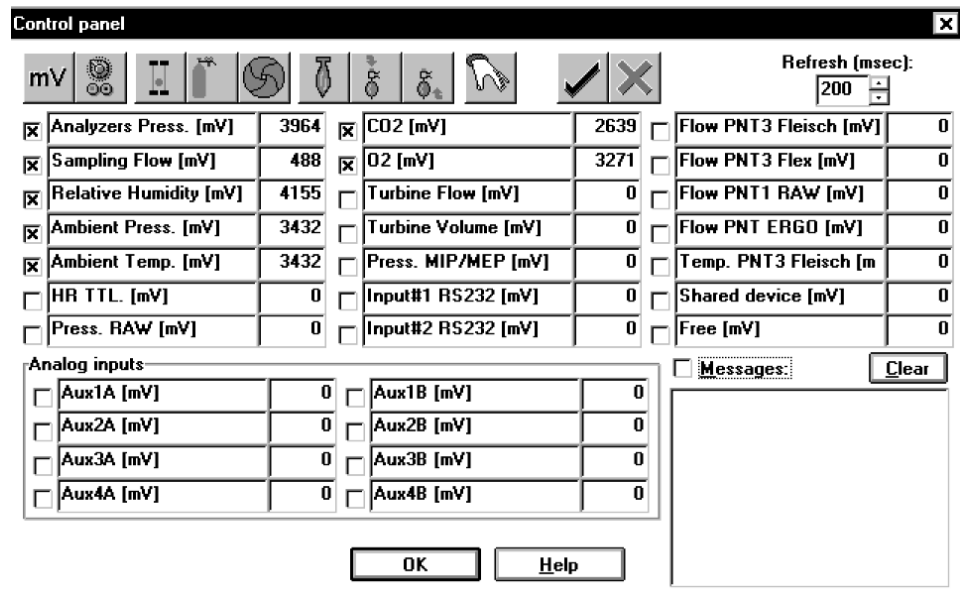

Using the control panel

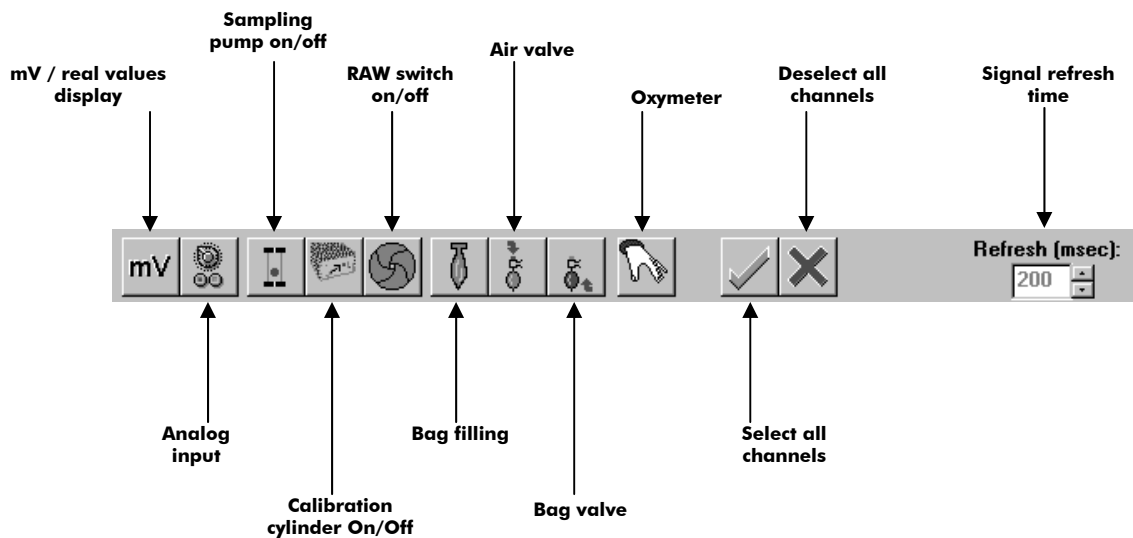



Database Management

Exercise testing patient's database

The exercise testing software uses a different interface for presenting patient information. The patient database allows to:

- Enter a new patient
- Find patient data
- Edit patient data
- Delete patient data.

Select **Patients** from the **File** menu.

Enter a new patient



1. Press **New** to show the Patient dialog box.
2. Enter data of a new patient and press **OK** button to confirm.

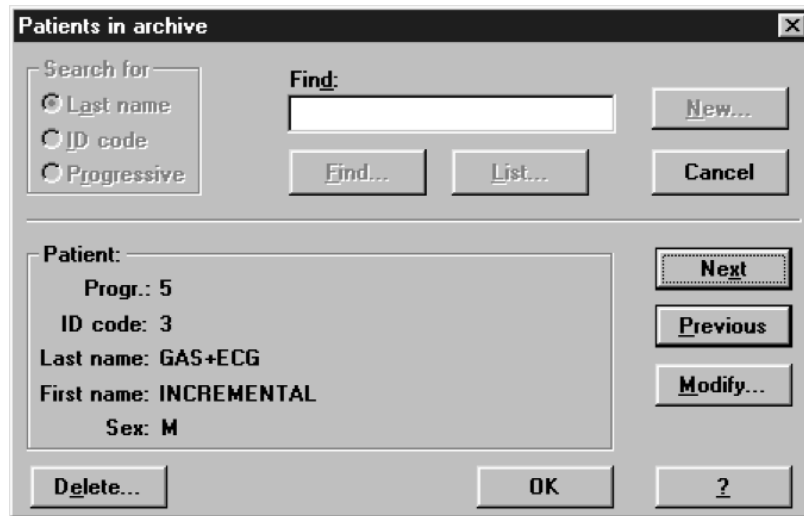

Find a patient

Enter a search string into the **Find** field and press **Find** to view the data concerning a subject already in the database. You can search for “Last name”, “ID code” or “Progressive”.

Or:

Press **List** to view the list of patients in the database. Press **Next** or **Previous** to view the data corresponding to the next or to the last patient. Press **OK** to confirm.

The **Next** and **Previous** buttons allow to move to the next or the previous patient in the database.

Edit patient data

1. Select the patient.
2. Press **Modify...** in order to edit the patient's data.
3. Edit the desired values and press **OK** to confirm.

Delete a patient

1. Select the patient to be deleted.
2. Press **Delete**.

Archive maintenance

The software allows to manage files selecting **Archive** from the **File** menu.

It is advisable to perform the archive reorganisation every month, in order to free space on the hard disk and/or to correct possible errors present within the database.

It is possible also that your have no more hard disk space. So, you have to delete all the data. In this case, it is useful to perform the initialising.

Reorganise the archive

1. Select **Reorganize archive** from the **File** menu.
2. Wait for the end of the operation before performing any other function.

Delete the archive

1. Select **Initialize Archive** from the **File** menu.
2. Wait for the end of the operation before performing any other function.

Delete a test

To delete an ergometry test, select **Test/Delete test**.

To delete a spirometry test, press the proper button in the Test Card.

Backup and restore

It is strongly recommended to backup files, a warning message will be displayed monthly. This function allows the user to restore the data if the PC or the HD will not work anymore.

Backup

1. Select **Backup archive** from the **File** menu.
2. Selecting the destination path with the **Browse** key or press **New** to create a new directory. Press **OK** to confirm.
3. In the dialog box it will appear an estimate of the number of floppy disks you need in order to back up the archives. Press **OK**.



Restore

1. Select **Restore archive** from the **File** menu.
2. On the **Restore** dialog box specify the drive source and press **OK**, a dialog box will appear indicating all data of the backup processed.

Spirometry patient's database



The Patients database consists of a Patient Card, a Visit Card and a Test Card in which are listed all tests performed by the patient.



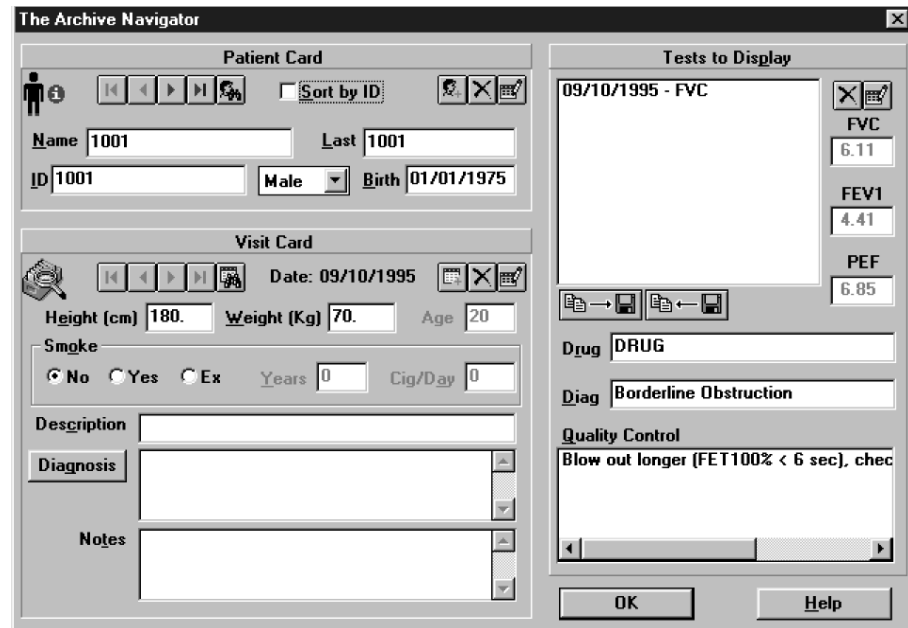





Select **Archive Navigator** from the **File** menu or press the button by side.



Patient Card

It collects all the information of a patient (first name, last name, date of birth) which remain the same for each visit. For each patient there is only one Patient Card, which is created the first time the Patient performs a test.

To move within the database use the following buttons:

-  Move to the first patient in the archive
-  Move to the previous patient in the archive
-  Move to the next patient in the archive
-  Move to the last patient in the archive
-  Find a patient in the archive
-  Enter a new patient in the archive
-  Delete current patient from the archive
-  Edit the current patient card







Note: after having deleted a record (patient, visit or test), it is recommended to reorganize the archive in order to free disk space.

Visit Card

It collects all information relative to the visit (diagnosis, visit description...) and to the patient information subject to change between one visit and another (height, weight, smoke). Each patient can be related to several Visit Cards provided they have been created in different days. Before carrying out any spirometric test it is necessary to create a new Visit Card or to open the today's Visit Card.

To move within the database use the following buttons:

-  Move to the first visit in the archive
-  Move to the previous visit in the archive
-  Move to the next visit in the archive
-  Move to the last visit in the archive
-  Find a visit in the archive



Enter a new visit card in the archive



Delete current visit card from the archive



Edit the current visit card

Test Card

It contains all the information about the test.

To move within the database use the following buttons:



Delete current test from the archive.



Edit the current test

Import/export a Tests card



This function allows to import /export a test card with the respective visit and patient card.

1. Select the patient.
2. Choose the test and press the key by side. All data will be imported/exported in the XPO file format (Cosmed proprietary).

Diagnosis Database

The program allows to manage a diagnosis database, whose records are composed by a diagnosis ID code and a string of text.

The report of the visits can be done either by typing the desired text in the field “Diagnosis” of the Visit Card or, more quickly, retrieving from the diagnosis database the desired one.

If you want to insert, modify or delete a diagnosis from the database select **Database Diagnosis...** from the **File** menu.

Spirometry program settings

The software allows to configure some options selecting **Configure** from the **Option** menu.

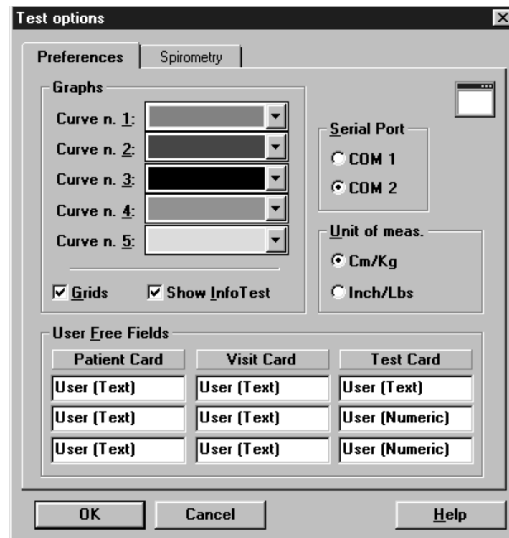

Graphs

All the graphs visualised and/or printed can be customised in colours and appearance.

1. Select the desired colours of the curves (5 curves max can be overlapped on the same graph).
2. Enable or disable the **Grid** option.
3. Enable or disable the **Show Info Test** option.

Serial port

You must select the serial port RS 232 that will be used to connect the Quark b² with the PC.

To select the serial port, click on the proper **COM** button (the selected port must be different from the mouse one).

Units of measurements

It is possible to configure the units of measurements, weight and height, for printing and viewing.

To select the units of measurement click on **cm/Kg** or **in/lb** according to the desired format.

Using extra fields

The Patient's database is organised in 3 different cards (Patient card, Visit Card and Test card.) where it is possible to store the information about patients and visits .

Besides the standard information, it is possible to customise some fields (user free fields), entering and labelling measurements coming from other devices.

The customisable free fields are:

- 3 fields in the Patient Card (Patient's information)
- 3 fields in the Visit Card (information about the visits)
- 3 fields (2 numeric) in the Test card information about Test)

Customise the fields

In the group **User free fields** type the desired text in the 9 fields available.

Exercise testing

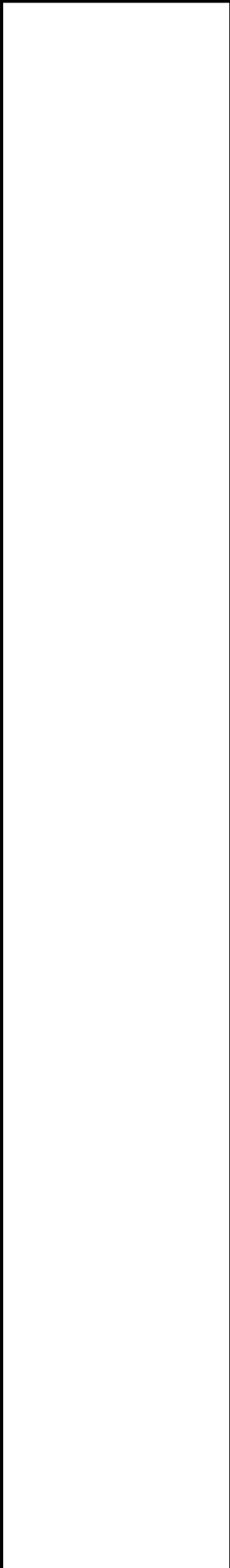

Recommendations for the exercise testing

The evaluation of the cardiorespiratory function

The physical training requires the interaction of physiological mechanisms that allow the cardiovascular and respiratory systems to supply the increasing demand of energy due to the contraction of the muscles.

During the training the systems are both engaged, an adequate answer to the effort is the measure of their health state.

The increase of the metabolic rate, during the exercise, needs an appropriate increase of oxygen in the muscles. At the same time, the CO₂ muscles production must be removed in order to avoid the lactic acid making.

To satisfy the increase in the gas exchange, necessary to the muscles during the exercise, is requested the intervention of many physiological mechanisms. This process involves lungs, the pulmonary circulation, the heart and the peripheral circulation.

Precautions

The physician has the responsibility that the patient subjects to the test is a suitable person able to execute an effort test.

Laboratory

The room, in which the test is performed, must be big enough to contain the whole necessary equipment, allowing an easier accessibility to the patient in case of emergency.

In the room should be placed a thermometer and a hygrometer; the heart frequency and the perceived values of the effort rise as much as the ambient temperature increases, and the variability of the cardiovascular response grows for humidity values higher of 60%. Generally it is considered 22°C the temperature adequate for the test execution, even for short efforts, values till 26°C can be considered acceptable in presence of an efficient air ventilation.

Ending the test

The patient should be monitored with ECG for at least 8 minutes, in resting conditions or until he returns to the pre-exercise conditions.

Preparing the patient

To enhance the value of a diagnostic test it's very important patient collaboration. In most cases a well-informed patient will make a better effort (in relation to his conditions) and will allow a reliable interpretation of the test. For this reason every ergometric test must be preceded from a precise training of the patient.

Before testing

The physician applying the exam must be provided with a written request including a brief description of the diagnosis (confirmed or suspected), the request's reason and the patient therapy carried out showing the dose and time of the drug assumption.

To standardise the response to the test and reduce the patient's anxiety it's suggested to provide him either written (before the exam) or oral (at the same time of the test) information. At the scheduling time detailed instructions should be delivered to the patient, consisting in smoke and food abstinence three hours before an ergometric test, or eight hours before a scintigraphic test.

Test are usually executed supporting the therapeutic outline in progress, but sometimes it could be necessary to stop some drugs, such as b-block or calcium antagonist, which could impair the effort response reducing the diagnostic accuracy of the exam.

The patient must wear comfortable suit and gymnastic shoes and two hours before test stop any kind of drugs, eat light and avoid coffee and smoke.

It's very important acquire information on the patient's clinical past before performing the test. Keep attention in particular way to the use of drugs, tobacco, to the physical fitness and symptoms produced with the exercise.

Patient assent

The patient is informed that he will be submitted to a maximum effort, which could be stopped at any moment, and of the risks of the test execution.

Ending the test

Test may end when the maximum value of the oxygen consumption has been reached and the patient's response established.

Start Testing

Before starting exercise test type a new patient information or choose one from the list of patient in the file. As soon as a patient has been entered the software is ready to start a test. The name of the active patient is shown on the status bar of the program window.

Start a test



1. Calibrate the analysers as described in the Calibration chapter.
2. Choose **Execute Test** from the **Test** menu.



Note: Selecting "Simulated test", the software allows to use the gas calibration in order to perform the test. This is useful if the user would check the accuracy of gas measurements.

Execute Test

Height (cm): 182.0
Weight (Kg): 88.0

Mode
 Gas
 ECG
 Gas + ECG
 Rest ECG
 Simulated test

Ergometer: (no one) [v]
Protocol: (no one) [v]
Workspace: User 1 [v]

OK
Other data...
Details...
Cancel

3. Enter or modify the antropometric data of the patient and select the options you need to carry out the test . To use a specific protocol choose it in the list box and press **OK** to confirm.
4. Select the ergometer you need to control
5. The software environment will change showing a new Menu bar and toolbar while the first data will be displayed in a table format.



6. At this point the software starts showing data on the monitor but without saving them, this in order to monitor the patient before starting the test. To start storing data press **F2**.



Abort the test without saving data

Choose **Abort** from the **Test** menu or press **Alt+F3**.



End the test saving data

1. Choose **End** from the **Test** menu or press **F3**.
2. Choose **Yes** to end the test or **No** to continue.

View data in real-time

The visualisation features and capabilities of the data and graphs are identical to the ones described in the Data management chapter. Starting the test a small window will appear on the right corner displaying time, bmp and, if selected before, the ergo protocol and trainer.

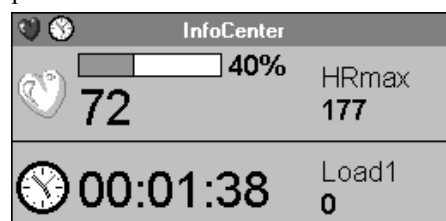



View graphs in real-time

1. Choose **Graph** from the **View** menu.
2. Follow the instructions described in *data management* section to edit the graphs.

Parameters to view

While the test is running, it is possible to choose the parameters to view.

1. Select **Parameters to view/Test execution...** from the **Options** menu.
2. Select the parameters and confirm.

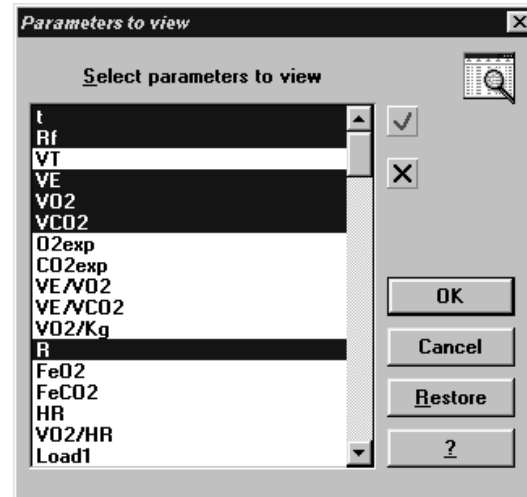

Manual protocol

If you are using the Quark with a treadmill without serial interface, it is possible to enter manually from the PC the event, the phase and the marker.



Tip: pressing the Shift key while choosing the marker option will allow you to enter the label for that marker.

Enter Load and Phase

1. During the test select **Load** from the **Events** menu.
2. Select the phase and/or type the value of the load and press **OK** to confirm.

Set the markers

Select **Marker** from the **Events** menu.



Automatic protocol

The software allows to automatically control the ergometer according to the protocol previously selected. Anyway it is allowed to change it even after the test is started.

Modify the load during the test

1. During the test choose **Ergometric protocol** from the **Events** menu.
2. Select the row corresponding to the desired load and press **OK** to confirm.



Set the BPM alarm

The software allows the user to set the alarm level for the heart rate, in order to monitor the patient response.

Enter the BPM

1. Choose **BPM alarm** from the **Events** menu.
2. Set the alarm by moving the scroll bar and press **OK** to confirm.

It also allows to enable or disable the acoustic alarm by the option "Acoustic alarm".

Data management

As soon as the test has been completed, all data stored can be retrieved for a complete management.

Viewing data

Data can be viewed in the following formats:

- Table form numeric values of the various parameters (columns) corresponding to each step (rows).
- Graphic form graphical presentation on Y1, Y2, X charts.
- Summary results of the test and statistical analysis of the blocks.
- Predicted predicted values, maximum value measured.



View data in table form

1. Select **Data...** from the **View** menu.
2. Select the test to visualise in the list box and press **OK**

▼▼▼▼
Note: Double-click in the window to open the edit test.

t	Rf	VT	VE	VO2	VCO2	VE/VO2	VE/VCO2	VO2/Kg	R	FeO2	FeCO2	HR	VO2/HR	Load	FetO2
hh:mm:ss	b/min	l	l/min	ml/min	ml/min	---	---	ml/min/Kg	---	%	%	bpm	ml/bpm	Watt	%
00:00:00	12.2	1.151	14.1	556	505	25	27	7.32	0.90	15.86	4.35	61	9.1	0	14.79
00:00:06	10.2	1.626	16.6	595	574	27	28	7.84	0.96	16.40	4.20	65	9.1	0	15.61
00:00:10	12.7	0.610	7.7	250	236	31	32	3.30	0.94	16.94	3.70	67	3.7	0	15.88
00:00:15	12.2	0.865	10.6	344	341	30	31	4.52	0.99	16.91	3.91	66	5.2	0	15.83
00:00:21	10.8	1.043	11.3	403	372	28	30	5.30	0.92	16.62	4.01	66	6.1	0	15.54
00:00:26	11.7	0.725	8.5	271	243	31	35	3.56	0.89	17.10	3.48	66	4.1	0	15.64
00:00:32	10.8	0.721	7.8	259	234	30	33	3.41	0.90	16.93	3.66	65	3.9	0	15.59
00:00:37	11.3	0.805	9.1	288	270	31	33	3.80	0.93	17.12	3.62	65	4.4	0	15.63
00:00:43	10.1	0.823	8.3	284	260	29	31	3.73	0.91	16.82	3.81	62	4.5	0	15.58
00:00:48	11.5	0.769	8.8	285	260	30	33	3.75	0.91	17.05	3.59	63	4.5	0	15.57
00:00:54	9.4	0.796	7.4	249	225	30	33	3.27	0.90	16.96	3.67	63	3.9	0	15.56
00:01:00	10.0	0.840	8.4	299	261	28	32	3.94	0.87	16.73	3.77	63	4.7	0	15.27
00:01:07	9.1	0.722	6.5	237	203	27	32	3.11	0.86	16.65	3.78	63	3.7	0	15.16
00:01:14	8.9	0.721	6.4	234	199	27	32	3.09	0.84	16.64	3.77	63	3.7	0	15.25
00:01:20	10.0	0.728	7.2	263	227	27	32	3.46	0.86	16.63	3.80	64	4.1	0	14.97
00:01:25	11.4	0.798	9.1	349	288	26	31	4.59	0.82	16.44	3.83	65	5.3	0	15.12
00:01:30	10.5	0.947	10.0	376	316	26	31	4.95	0.84	16.51	3.85	66	5.7	0	15.15
00:01:36	10.8	0.888	9.6	339	294	28	32	4.46	0.86	16.72	3.74	65	5.2	0	15.25
00:01:42	10.8	0.917	9.9	352	309	28	32	4.63	0.87	16.73	3.77	64	5.5	0	15.35
00:01:47	10.9	0.846	9.2	323	283	28	32	4.25	0.87	16.77	3.74	64	5.0	0	15.29
00:01:53	10.9	0.848	9.2	315	274	29	33	4.15	0.87	16.86	3.61	64	4.9	0	15.63
00:01:58	10.7	0.881	9.4	329	292	28	32	4.32	0.89	16.78	3.77	64	5.1	0	15.33
00:02:04	11.0	0.761	8.4	289	249	29	33	3.80	0.86	16.86	3.61	65	4.4	0	15.51
00:02:09	10.5	0.817	8.6	286	261	30	33	3.77	0.91	16.95	3.69	64	4.4	0	15.62
00:02:15	11.2	0.876	9.8	320	283	30	34	4.21	0.88	17.06	3.50	65	4.9	0	15.65
00:02:20	11.1	0.907	10.1	337	286	29	35	4.44	0.84	16.97	3.46	66	5.1	0	15.69
00:02:25	10.9	0.795	8.6	275	246	31	35	3.62	0.89	17.14	3.46	65	4.2	0	15.68
00:02:31	11.5	0.795	9.1	312	269	29	34	4.10	0.86	16.89	3.57	65	4.8	0	15.58
00:02:36	10.7	0.829	8.9	303	269	29	33	3.99	0.88	16.87	3.67	65	4.6	0	15.50
00:02:42	10.9	0.736	8.0	269	234	30	34	3.54	0.86	16.96	3.53	64	4.2	0	15.57
00:02:47	10.7	0.821	8.8	299	260	29	34	3.94	0.86	16.89	3.59	65	4.6	0	15.45
00:02:52	11.3	0.875	9.9	335	297	29	33	4.41	0.88	16.91	3.65	65	5.1	0	15.50
00:02:58	11.5	0.862	9.6	322	292	29	34	4.24	0.88	17.05	3.68	65	4.9	0	15.54

Creating graphs

The software is provided with powerful functions for creating charts. You can add custom graphs to create exactly what you need.



View data in graph form

1. Choose **Graph...** from the **View** menu.
2. Select the tests to visualise from the list and press **OK**
3. Choose the parameters you require on the X, Y1 and eventually for Y2; select if necessary some of the following options by pressing the **more** button and press **OK** to confirm.

It is possible to access quickly 5 common graphs from the **View/Graph...** dialog box.



Note: Double-click in the graph window to open the edit test

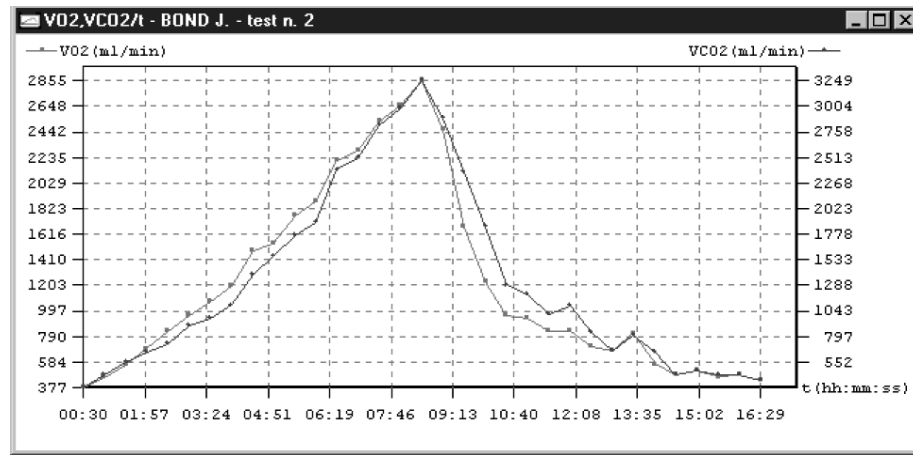

Right-clicking, the graph can be exported in bmp file format.

Customise the graphs

1. With a graph on the screen, choose **Customise graph** from the **View** menu.
2. On the Customise graph dialog box, select options to obtain the wished graph.

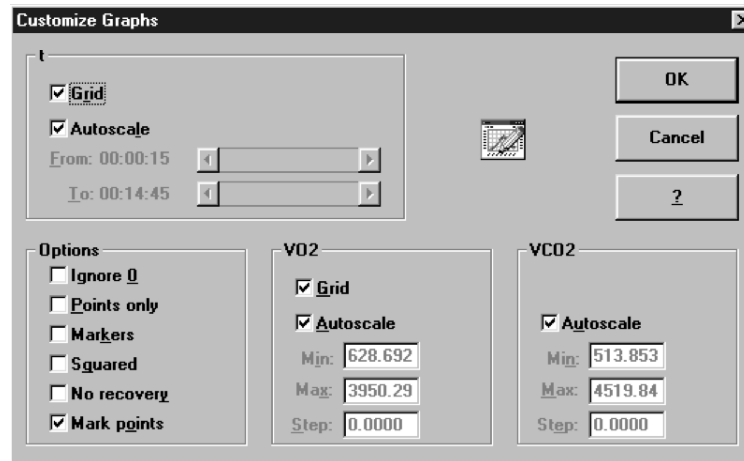

Option	Function
Grid on X, Y axes	show the grid lines in correspondence with x or y axes that make the graph easier for you to analyse data.
Autoscale	maximum and minimum values of the graph will be measured automatically.
Ignore 0	points with 0 value measured won't be shown.
Not interpolated	make the graph scattered.
Marker	highlight with a symbol all steps of the test in which the marker button was pressed.
Squared	makes the graph a square
Without recovery	exclude from the graph all points of the recovery phase.
Mark points	marks each point with a symbol
Min. Max.	allows to set manually the axes values.
Step	Set the axes' scale step.

Switch from graph to data and vice versa

When the active window is a graph (or a report in data form), it is possible to view very quickly the data (or the graph) corresponding to that test.

Choose **Current test data** (if the active window is a graph) or **Current test graph...** (if the active window is a data report) from the **View** menu.



Viewing predicted values

For some parameter it is possible to compare the maximum value measured during the test with its predicted value and the LT value both in percentage and absolute.

View predicted values

Choose **Predicted** from the **View** menu.



Parameter	Values @LT	Max	Max Predicted	% Predicted
t (hh:mm:ss)	----	----	00:14:13	----
Load (Watt)	----	450	225	200.00
Real Load (Watt)	----	----	----	----
Revolution (RPM)	----	----	----	----
VO2 Max. (ml/min)	----	3534	2964	119.24
VO2/Kg Max. (ml/min/Kg)	----	46.50	39.00	119.24
VE (l/min)	----	139.0	161.3	86.19
RE (l/min)	----	34.2	50.0	68.45
VT (l)	----	4.48	2.81	159.90
R (---)	----	1.82	----	----
VO2/HR (ml/bpm)	----	24.7	16.3	150.93
VE/VO2 (---)	----	57	----	----
VE/VO2 (---)	----	35	----	----
P Syst (mmHg)	----	----	----	----
P Diast (mmHg)	----	----	----	----
HR max (bpm)	----	153	181	84.53
HR (bpm)	----	28	----	----
BR (%)	----	22.27	----	----
REE (kcal/day)	----	----	1738.7	----
VO2LT (ml/min)	----	----	1274	----
VO2LT (ml/min)	----	3534	3059	115.54
VO2/KgLT (ml/min/Kg)	----	46.50	40.25	115.54

Anaerobic (Lactate) Threshold detection

The software allows to detect the Lactate Threshold (Anaerobic Threshold) according to the "Modified V-slope method" reference. The LT can be detected both manually and automatically.

View the Lactate Threshold

Choose **Lactate Threshold** from the **View** menu.



Detect the Lactate Threshold

1. Choose **Calculate LT** from the **Test** menu.
2. For calculating it automatically on the "Lactate Threshold" dialog box click on the **Auto detect** button.
3. For adjusting manually the point you want to detect, move the scroll bar on the dialog box by pressing the arrow buttons. Data and graph of the LT will be automatically redrawn.
4. Press **Ok** button to save your choices.

▼▼▼
Note: Double-click in the window to open the corresponding dialog box.

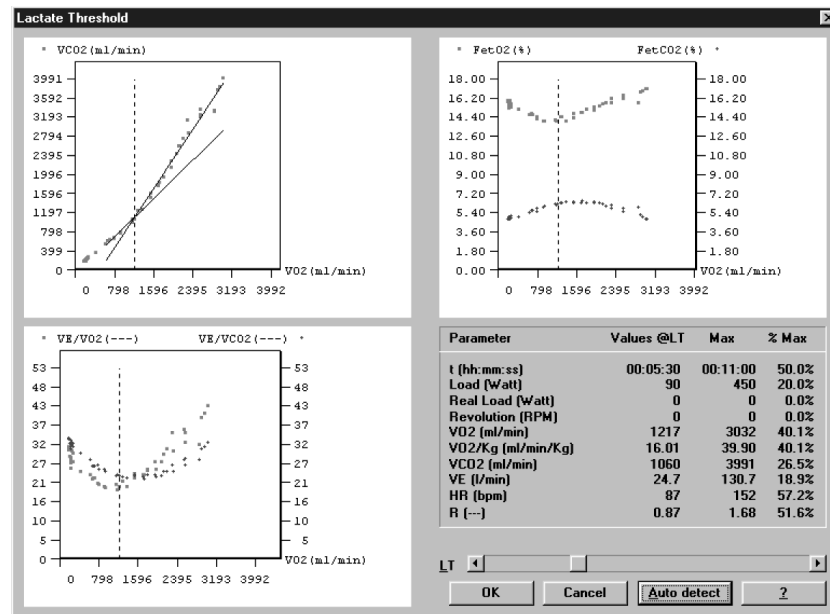

Customise graphs for the LT viewing

The software allows to customise two of the three graphs for the LT visualisation.

1. Choose **Lactate Threshold** from the **Options** menu.
2. Choose the parameters you want to be shown on the LT window and press **OK** to confirm your choices.

Fittings

The purpose of the fitting function is to find the function that fits as better as possible the measured data.

The software allows to fit data according to 3 different functions:

Model	Function	Algorithm	Available for
Linear	$Y=A*X+B$	Least squares	Any Y vs any X graph
Mono-Exp	$Y=A+B*\exp[(t-t_0)/\tau]$	Levenberg Marquardt	Any Y vs Time Graph
Mean value			

This function is available only if the active window is a single Y graph (i.e. VO_2 vs time or VO_2 vs Load).

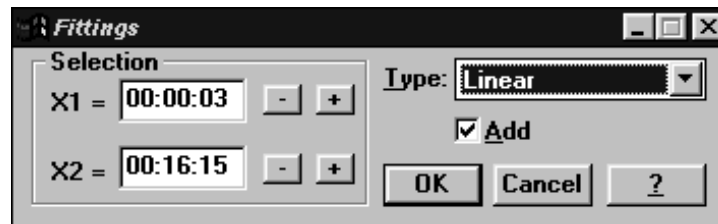

Fit a graph with a linear regression

1. Make active the graph window (any Y vs any X graph).
2. Right-click and select **Fitting**.
3. Choose **Linear** in the type combo box
4. Select the first point (**X1**) moving the mouse on the desired place in the graph pressing the **Left** key or using the + and – keys.
5. Select the second point (**X2**) moving the mouse on the desired place in the graph pressing the **Right** key or using the + and – keys.
6. Press **OK** to confirm.

Fit a graph with a Mono-exponential regression

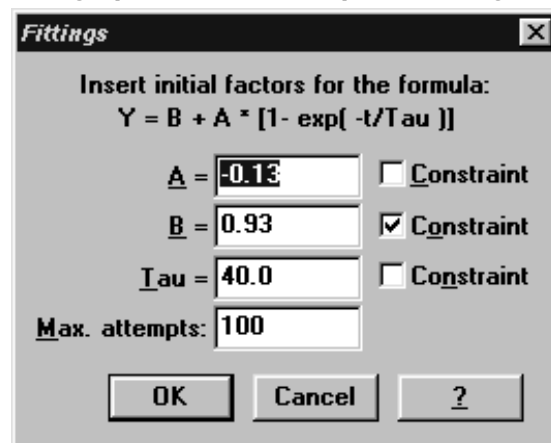

1. Make active the graph window (any Y vs any X graph).
2. Right-click and select **Fitting**.
3. Choose **Mono-exponential** in the type combo box
4. Select the first point (**X1**) moving the mouse on the desired place in the graph pressing the **Left** key or using the + and – keys.
5. Select the second point (**X2**) moving the mouse on the desired place in the graph pressing the **Right** key or using the + and – keys.
6. Enter (if necessary) the initial values of A, B and TAU (these are the values from which the iterative algorithm starts in order to reach the best values; the closer are the initial coefficients to the best ones the higher is the possibility to reach the best fit).
7. Press **OK** to confirm.

Calculate the "Mean Value"

1. Make active the graph window (any Y vs any X graph).
2. Right-click and select **Fitting**.
3. Choose **Mean value** in the type combo box
4. Select the first point (**X1**) moving the mouse on the desired place in the graph pressing the **Left** key or using the + and – keys.
5. Select the second point (**X2**) moving the mouse on the desired place in the graph pressing the **Right** key or using the + and – keys.
6. Press **OK** to confirm.

*Note: The results of the O2 Fittings function are not stored therefore, in order to keep the information, print the page using **File/print Active Window**.*

Oxygen Kinetic

This function is available only if the active window is a VO₂ vs time graph and it has a sense only with Constant Load Exercise Tests.

The aim of this function is to find the dynamic response of the rising and falling edges of the VO₂ together with the Oxygen Deficit and Oxygen Debt.

Init. Fact. O2def		Init. Fact. O2debt		Selection	
A1 =	1657 <input type="checkbox"/> C	A2 =	-1657 <input type="checkbox"/> C	t1 =	00:03:50 - +
B1 =	735 <input checked="" type="checkbox"/> C	B2 =	2393 <input checked="" type="checkbox"/> C	t2 =	00:11:30 - +
Tau1 =	40.0 <input type="checkbox"/> C	Tau2 =	40.0 <input type="checkbox"/> C	Max. attempts:	100

Run the O2 Kinetic function

1. Make active a VO₂ vs Time graph window.
2. Press the right key of the mouse and select **O2 Kinetic**.
3. Select the beginning of the exercise phase (**t1**) moving the mouse on the desired place in the graph pressing the **Left** key or using the + and - keys.
4. Select the beginning of the exercise phase (**t2**) moving the mouse on the desired place in the graph pressing the **Right** key or using the + and - keys.
5. Enter (if necessary) the initial values for A, B and Tau (these are the values from which the iterative algorithm starts in order to reach the best values; the closer are the initial coefficients to the best ones the higher is the possibility to reach the best fit) and press **OK**. You can lock data checking the relative field

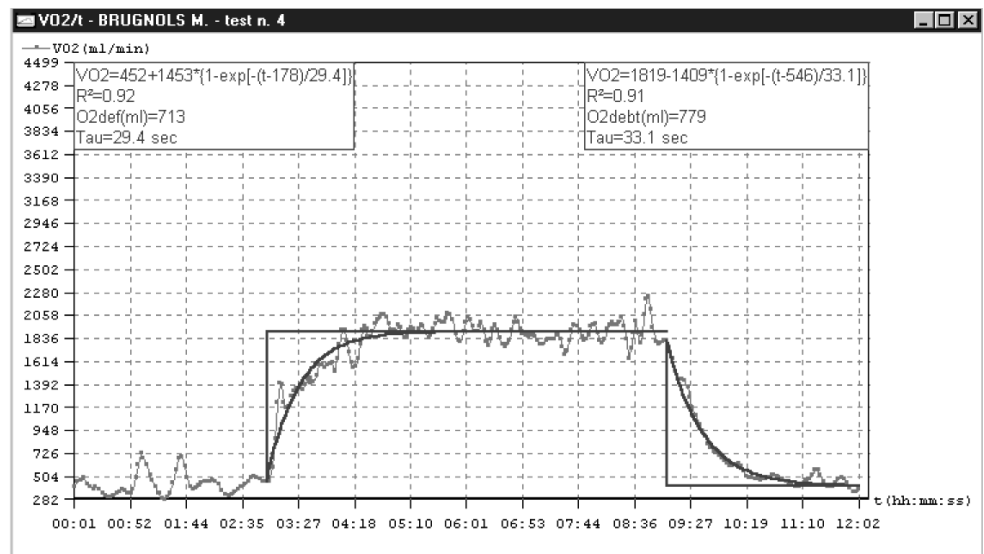

Information about the Test

The Test Information dialog box shows all the information concerning environmental data, patient data and some data about the test



View the Information

Choose **Information** from the **View** menu.

Modify the information

1. Press the **Modify** button on the **Information** dialog box.
2. Change the values you want to modify and press **OK** to confirm.

The software allows to assess the energy expenditure and metabolism substratum. In order to measure FAT and CHO, type the UN (Ureic Nitrogen) value into the field. All the nutritional parameter will be recalculate considering the UN value.

Summary

The summary feature allows to summarise test results according to the workload and phase during the test.

View the summary

1. Choose **Summary** from the **View** menu.
2. The summary of the current test (active window) will be displayed.

Rf	VT	VE	VO2	VCO2	VE/VO2	VE/VCO2	VO2/Kg	R	FeO2	FeCO2	HR	VO2/HR	FetO2	FetCO2	
b/min	l	l/min	ml/min	ml/min	---	---	ml/min/Kg	---	%	%	bpm	ml/bpm	%	%	
Phase n. 1 Rest Start: 00:00:00 End: 00:01:08 Speed: 0, Load2: 0, Load3: 0															
Min	14.6	0.586	8.6	212	157	28	35	3.16	0.73	16.51	2.49	88	2.2	15.09	4.12
Max	21.0	0.971	20.3	619	489	39	52	9.24	0.82	17.68	3.58	107	6.6	15.90	4.76
Average	16.8	0.747	12.7	349	272	33	43	5.22	0.77	17.23	2.95	94	3.6	15.60	4.29
Trend	19.8	0.853	16.9	542	429	28	36	8.09	0.79	16.65	3.47	106	5.1	15.21	4.65
Phase n. 2 Exercise Start: 00:01:10 End: 00:07:05 Speed: 4, Load2: 0, Load3: 0															
Min	17.5	0.811	16.7	540	420	23	28	8.06	0.72	15.75	3.54	110	4.7	14.34	4.37
Max	51.5	2.883	138.1	3367	3978	45	36	50.25	1.32	17.99	4.37	196	18.7	17.20	5.36
Average	34.4	1.904	70.1	2074	2148	30	31	30.96	0.97	16.77	3.90	160	12.4	15.76	4.88
Trend	46.3	2.659	123.2	3158	3704	37	32	47.13	1.17	17.50	3.80	187	16.8	16.80	4.71
Phase n. 3 Recovery Start: 00:07:07 End: 00:10:43 Speed: 0, Load2: 0, Load3: 0															
Min	25.2	1.170	34.0	477	834	33	28	7.13	1.16	16.95	3.02	130	3.3	16.09	3.82
Max	43.2	2.799	118.0	3143	3647	74	41	46.92	1.87	18.87	4.43	190	16.5	18.21	5.42
Average	34.6	1.880	66.3	1368	1910	51	35	20.42	1.45	18.11	3.57	156	8.3	17.41	4.45
Trend	30.6	1.268	38.8	770	968	47	37	11.50	1.25	18.10	3.29	132	5.8	17.50	4.12



Tip: double-clicking on the Summary window the function **Options/Summary** is activated by which you may configure the structure of the data.

Print the data

It is possible to print graphs and data by means of two functions: **Print report** and **Print current window**. The last one is active only if the active window is a graph or a data report.

Print the current window



1. Be sure that the current active window is the graph or the report you desire to print.
2. Select **Print current window** from **File** menu.
3. Press **OK** to print, or **Setup** to customise the print.

Print the report



1. Select the report to be printed from **File** menu.
2. Press **OK** to print, or **Setup** to customise the print.
3. To only view the report, without printing it, press **Shift** during the selection.

View the report

This function allows to show a preview of a selected report.

1. Select **Report** from the **View** menu.
2. Select the test and the report to visualise and press **OK** to confirm.

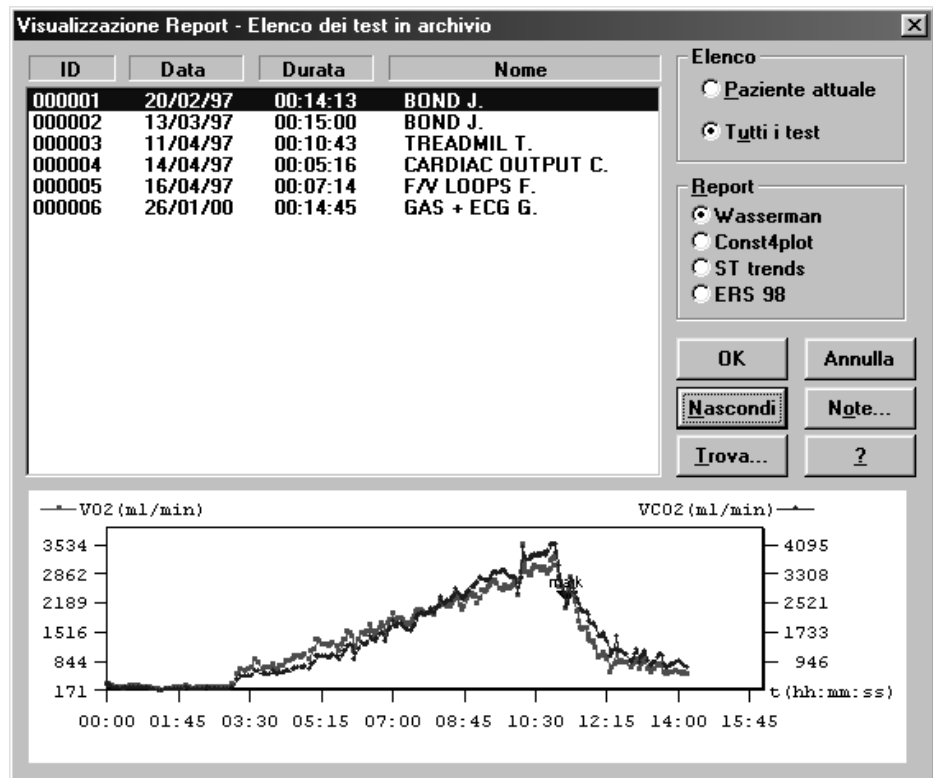

Data Editing

The software allows the user to edit the data acquired during the test in the following ways:

- deleting one or more steps
- editing row data
- input new parameters
- data filtering (averaging or smoothing)
- advanced data elaboration

After data elaboration it is always possible to restore the original data file by pressing the **Restore** button .

If you want to save permanently all the changes, press **Overwrite**; being aware this function replaces the original test definitely.



Nota: In Data view, double-click in the window to enter in "Data Editing".



Editing values and input numerical values

1. Choose **Edit test** from the **Test** menu.
2. Select the cell containing the value you want to replace with others values and press **OK** to confirm the editing.

The software will recompute all the parameters. Both the tables and the graphs will be automatically updated.

Time	Ti	Te	IV	VT	O2exp
00:00:03	1.23	2.35	0.69	0.912	154.4
00:00:06	1.40	2.22	0.93	1.133	192.0
00:00:11	1.39	2.49	0.90	1.121	190.5
00:00:15	1.41	2.40	0.86	1.018	172.8
00:00:19	1.40	2.54	0.87	1.020	172.9
00:00:23	1.48	2.57	0.90	1.041	176.3
00:00:27	1.41	2.61	0.84	0.935	159.0
00:00:30	1.44	2.43	0.82	0.919	156.5
00:00:34	1.43	2.46	0.84	0.947	161.6
00:00:38	1.46	2.29	0.83	0.960	164.5
00:00:41	1.40	2.25	0.80	0.936	160.7
00:00:45	1.44	2.25	0.78	0.956	163.6
00:00:49	1.39	2.27	0.77	0.921	157.4

Data filtering

1. Choose **Edit test** from the **Test** menu.
2. Press the button **Filtering** and choose the option **Discard invalid steps** to automatically eliminate all the invalid steps
3. Press the button **Filtering** and choose the option **Averaging** and type the desired value for points Ave/smooth to perform an averaging of the all acquired steps. This feature reduces the size of the original test.
4. Press the button **Filtering**, select the option **Smoothing** and type the desired value for **points**. This feature doesn't reduce the size of the original test, although it smoothes the fluctuation of data.

Using the User fields

The software is provided with three free fields in which the user may enter values coming from others devices such as lactate, blood pressure etc.

To define the user fields:

1. Choose **User Fields** from the **Options** menu
2. Type the desired text in the input fields and press **OK**.

To enter values in the user fields:

1. Choose **Edit test** from the **Test** menu.
2. Scroll horizontally until the fields USER 1, 2 and 3.
3. Enter the desired values and press **OK** to confirm.

Deleting steps

This feature is useful whenever some steps acquired during the test are to be discarded (steps acquired before the start of the test, patient disconnected from the face mask...).

1. Choose **Edit tests** from the **Test** menu.
2. Position the cursor on the step you want to delete and press the button **Delete step**.

Advanced Editing

This feature allows to perform some advanced editing of the data stored in the software.

1. Choose **Edit test** from the **Test** menu.
2. Press the **Advanced** button and select from the following options:

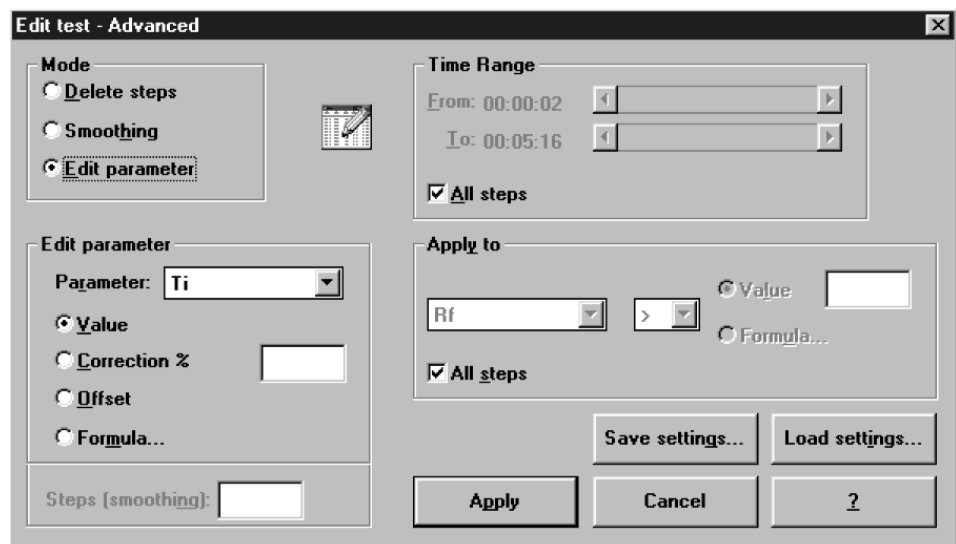

Option	Function
Delete steps	deletes the steps meeting the selection criteria
Smoothing	applies a moving average to the selected parameter
Edit parameter	edits a parameter according to the selected criteria
Edit parameter	Specifications
Value	replaces the value of the selected parameter with a new one.
Correction %	applies a percentage correction to the value of the selected parameter.
Offset	adds an offset to the value of the selected parameter.
Formula...	replaces the value of the selected parameter with a mathematical function.
Time range	Specifications
From, To	specifies the time range.
All steps	applies the editing from the beginning to the end of the test.

Apply to	Specifications
Parameter	specifies the reference parameter
>, >=, =, <, <=, <>	higher than, higher or equal, equal to, lower than, lower or equal, different
Value/Formula...	specifies the value (mathematical expression) compared with the value of the specified parameter.
All steps	do not use any selection criteria.

Restore the original test

To cancel all the editing, in the "Edit Test" dialog box press the **Restore** button, confirm your choice by pressing **yes**.

Overwrite the original test

To save all the editing, replacing the original test with the modified one, in the "Edit Test" dialog box press the **Overwrite** button, confirm your choice by pressing **yes**.

Customise the desktop

Customise the display colours

1. Select **Colors** from **Options** menu.
2. Select the item to be modified.
3. Press **Change** and select the desired colour.

Smart edit

This function is useful to correct data from artefacts; the noise affecting the measured data can be reduced in 2 different ways:

Graphical noise suppression using the mouse

Threshold noise suppression applying a filter to the measured data

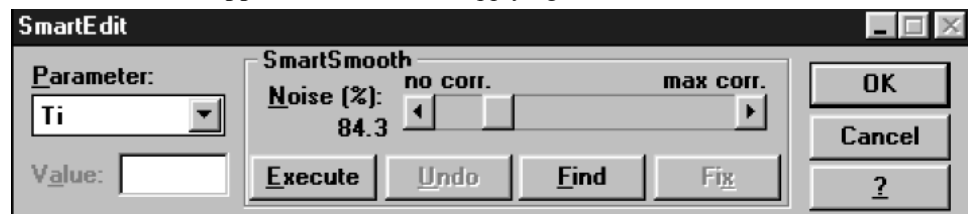

Apply the graphical noise suppression

1. Make active a graph or a data window corresponding to the test that you want to modify.
2. Press the **right key** of the mouse and select **Smart Edit**.
3. Select the parameter that you want to modify.
4. Point the mouse on the position where the graph presents the artefacts, click the **Right key** and, keeping pressed the key, drag the point on the desired place.
5. If you want to cancel the edit press the **Left key** of the mouse.
6. Repeat the above mentioned procedure for the all parameters and press **OK**.

Apply the threshold noise suppression

1. Make active a graph or data window corresponding to the test that you want to modify.
2. Press the **Right key** of the mouse and select **Smart Edit**.
3. Select the parameter that you want to modify.
4. Set a **Noise(%) Threshold** (as a percentage of the parameter value) above which any peak will be considered an artefact.
5. Press **Execute** and eventually **Undo** if you are not satisfied.
6. Press **OK** to confirm.

Customise the parameters

The software allows the user to create customised parameters and predicted values, derived from the standard parameters (the ones that are calculated by default) through any mathematical formula.

All the customised parameters can be used freely for viewing and printing purposes.

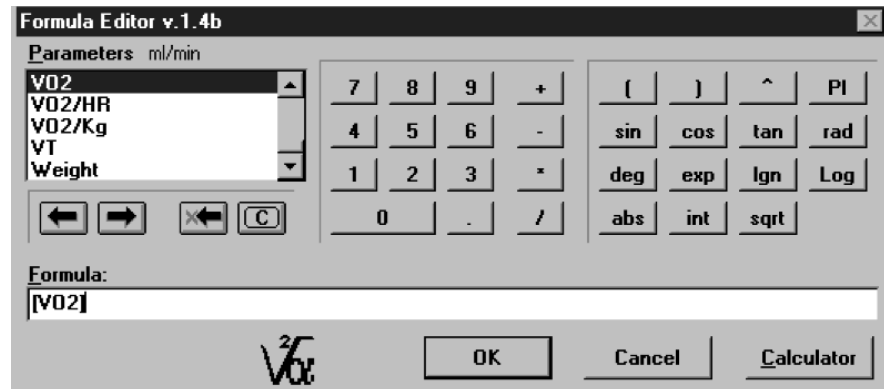

Create a new parameter



1. Choose **Customise parameters** from the **Options** menu.
2. Press the **New** button if you want to create a new parameter or **Modify** if you want to modify an existing one
3. Type the desired value in the fields "Name", "unit of meas", "integers", "decimals" and "summary" (to present the parameter in the summary) and press the **Formula** button.
4. Insert the mathematical formula by using the appropriate tools and press **OK** twice to confirm.



Create a new predicted parameter

1. Choose **Customise predicted** from the **Options** menu
2. Press the **New** button if you want to create a new parameter or **Modify** if you intend to modify an existing one
3. Type the desired value in the fields "Name", "unit of meas", "integers", "decimals".
4. Select the group of the predicted values from the options boxes.
5. Select the reference parameter in the "Compared to" list box.
6. Press the buttons in the calculation group and insert the mathematical formulas for men and women, adults and paediatrics. Press **OK** twice to confirm.

Once you create the new predicted you can see it in the predicted window.

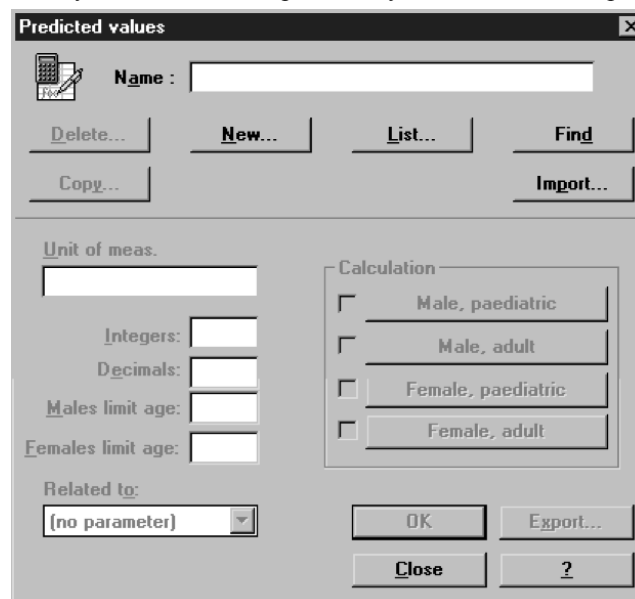

Exporting data

With this function you can export the tests data and parameters in different file formats:

- *.xpo (Cosmed proprietary file format)
- *.txt (ASCII)
- *.xls (Microsoft Excel)
- *.wk1 (Lotus 123)



Export a test

1. Choose **Export Tests** from the **Test** menu.
2. Select the test to export from the list box and press **OK** to confirm.
3. Select the file output format from the list box, click on ***.xpo**, ***.txt**, ***.xls** or ***.wk1**. If you selected ASCII format, by clicking on **Text** button you can then select the **Thousands sep.** and **Column sep.** according to the program you want to use. With the **xpo Cosmed format** you can import/export the tests performed on another Quark equipment.
4. Select the folder, type the file name and press **OK** to confirm.

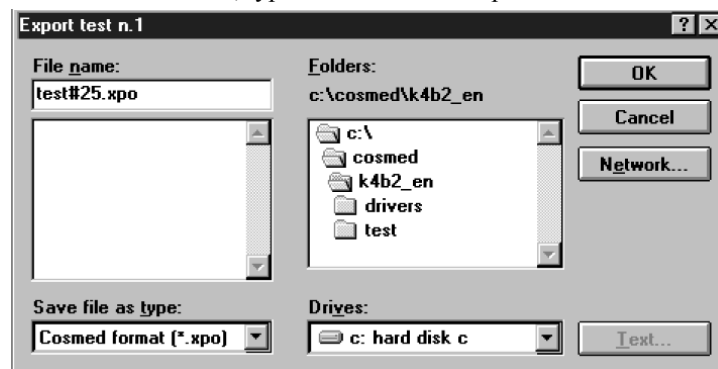

Note: The DDE function is available only if the user PC has Microsoft Excel installed.

DDE with Excel

If Microsoft Excel is installed on your PC, you can export a test simply pressing a button on the toolbar.

To send a test to Excel, select **Send to Excel** from the **Test** menu.

The program will show a status bar indicating the data transmission to Excel. At the end of the process a new sheet with all test data will be opened ready to be edited with the powerful functions of Microsoft Excel.



Creating Test Protocols

The software allows to create different exercise protocols to use during the test. The load of the ergometer is automatically controlled by the software that change it according to the defined protocol.

Create a new protocol

1. Choose **Real Time > Ergom. Tests Protocols** from the **Options** menu.
2. Press **New** and enter a name for the protocol.
3. In the field "Message Time" type a number that means to get a message to advise when switching to the next load.
4. Enable the "Drive Ergometer" check box to let the software control the ergometer. Select the "Initial Command" if the ergometer need it.
5. Enabling the option "Relative Increments", the loads refer to the previous step.
6. Press **Generate** and enter the values to generate a protocol from only one load (i.e. 30 Watt each minute for a total of 20 steps) and press **OK** to confirm.
7. Press **Add** if you want to add a new step.
8. To edit a step, select it from the list and change the relative values in the **Edit** boxes below the list. Press the Tab button to save changes.
9. To delete a step, highlight the step and press **Delete**.

t	Speed	Elevation	Phase	Command
00:00:02	0	0	1	(no one)
00:01:00	0	0	2	(no one)
00:02:00	5	0	3	(no one)
00:02:20	10	0		(no one)
00:02:40	15	0		(no one)
00:03:00	20	0		(no one)
00:03:20	25	0		(no one)
00:03:40	30	0		(no one)
00:04:00	35	0		(no one)
00:04:20	40	0		(no one)

Software configuration

The software can be customised as you wish. Most of the feature are easily editable to be tailored according to different purposes.

Data viewing

The software allows to calculate a huge number of parameters; it is advisable, in order to simplify the analysis of the results, view in the data window the only desired parameters.

Select the parameters to view

1. Choose **Parameters to view/Test visualisation...** from the **Options** menu.
2. Select the parameters you require to view.
3. Press **OK** to confirm the selected configuration.

Select the parameters to view during the test

1. Choose **Parameters to view/Test execution...** from the **Options** menu.
2. Select the parameters you require to view.
3. Press **OK** to confirm the selected configuration.

Sort the parameters

It is possible to sort the parameters (both for viewing and printing purposes) according to the desired order.

1. Select **Sorting parameters** from the **Options** menu.
2. Move the parameters in the order you want by pressing and holding the left mouse button.
3. Press **OK** to maintain the current configuration.

Steady State

The program has an algorithm to tag sets of steps as Steady State.

The algorithm considers belonging to the Steady State the only consecutive steps that meet the following conditions:

- The value of VO_2 , VE and R do not vary from their mean values more than **Threshold (%)**;
- The number of consecutive steps that met the preceding criteria are at least **Minimum number of steps**.

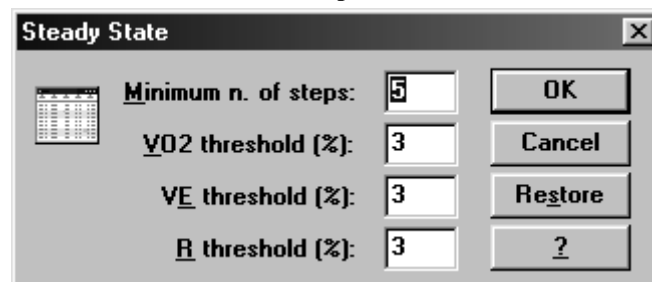

Customise the Steady State detection criteria

1. Choose **Steady State** from the **Options** menu
2. Type the desired values for **Minimum number of steps**, **VO_2 threshold (%)**, **VE threshold (%)** and **R threshold**.

The steps which satisfy these conditions will be highlighted with a yellow bar.

Printout reports

The software allows the user to printout data and graphics according to 4 customisable reports. Further it allows the user to customise a printout header that will be printed in each page.

Set up the printout

1. Choose **Reports** from the **Options** menu.
2. Define the desired features of the report and confirm. Enabling the option "Graphs in one page" all the graphs selected in the report will be printed in one page.
3. Type the name you want apply to the report and press **OK** to save changes.

Print	Y1 Axis	Y2 Axis	X Axis	More...
N.1 <input checked="" type="checkbox"/>	VE	Load1	t	More...
N.2 <input checked="" type="checkbox"/>	HR	VO2/HR	t	More...
N.3 <input checked="" type="checkbox"/>	VO2	VCO2	t	More...
N.4 <input checked="" type="checkbox"/>	VE	(no graph)	VCO2	More...
N.5 <input checked="" type="checkbox"/>	HR	VCO2	VO2	More...
N.6 <input checked="" type="checkbox"/>	VE/VO2	VE/VCO2	t	More...
N.7 <input checked="" type="checkbox"/>	VT	(no graph)	VE	More...
N.8 <input checked="" type="checkbox"/>	R	(no graph)	t	More...
N.9 <input checked="" type="checkbox"/>	PetO2	PetCO2	t	More...
N.10 <input type="checkbox"/>	Rf	(no graph)	t	More...
N.11 <input type="checkbox"/>	Rf	(no graph)	t	More...
N.12 <input type="checkbox"/>	Rf	(no graph)	t	More...

Select parameters to be printed

Quark allows to print a large number of parameters; it is advisable, in order to simplify the analysis of the results, to printout desired parameters only.

1. In the report configuration window select **Parameters**.
2. Select the parameters you require to be printed in the data printout. The number of parameters which can be printed depends upon the size of the paper in use (see Printer Layout) and from the orientation of the sheet.
3. Press **OK** to confirm the selected configuration.

Customise the printout header

1. Choose **Printout header** from the **Options** menu.
2. On the "Report Header" dialog box type the text of the header.
3. To insert an image click the **Logo** button. An image editor will be opened, draw the own logo and close the image editor to save changes.
4. Press **OK** to save the Printout header.

Electronic reports (*.pdf)

If an Adobe PDF writer “Printer Driver” is installed and set as the default printer, it is possible to store the printout report automatically in any location of the HD or eventually LAN paths according to a customizable filename format.

It is possible to define the created filename format selecting **Options/Printout header...**, and then **Name format...**

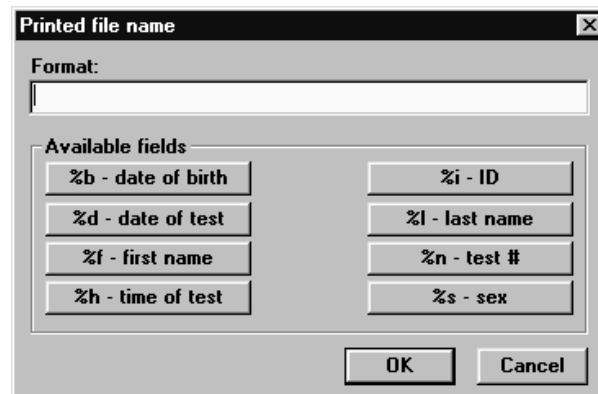

Print the current window

The print current window function is enabled when the active window is a graph or a data report.

1. Select **Print current window** from **File** menu.
2. Press **OK** to print, or **Setup** to customise the print.

Print the customised report

This function is enabled only after having customised a report.

1. Select the customised report from **File** menu.
3. Set the sheet format and press **OK**.

Events management during exercise testing

Cardiac Output (option)

The test is a non invasive method based on the measurement of the carbon dioxide during an exercise test for the indirect measurement of the Cardiac Output; the manoeuvre is composed by two different phases:

- Measurement of the metabolic parameters during a **steady state** condition (both at rest or during exercise, usually at the end of the 3rd minute of a 5 minutes step);
- Rebreathing in a bag previously filled with a high CO₂ mixture and measurement of the CO₂ concentration reached at the equilibrium.

The method is base on the hypothesis that the PCO₂ in the alveolar gas is approximately equal to the one of the lung capillaries.

The rebreathing phase consists in making the patient breathing into a bag (typically 5 litres) containing an high concentration of CO₂ in O₂ balance that, mixing with the expired breath, brings to constant average value.

The optimum value of the CO₂ concentration of the cylinder and the bag depends on the workload, and can be desumed from the following table:

Load (W)	CO ₂ concentration (%)
50	10.5/11.5
100	11.0/12.0
150	12.0/13.0
200	13.0/14.0

Balance O₂.

The volume of the mixture filled in the bag must be 1.5 - 2 times the V_t of the patient.

Note: The Cardiac Output must be carried out only with the mask without inspiratory valves or with the mouthpiece otherwise the results are not reliable.

Setting up the Quark b² for the cardiac output

1. Connect and open the Cardiac Output cylinder to the corresponding input port on the rear panel (the output pressure of the gas must be between 4 and 5 bar).
2. Connect the valve to the corresponding connector of the front panel of the system.
3. Connect the rebreathing bag to the valve assembly.

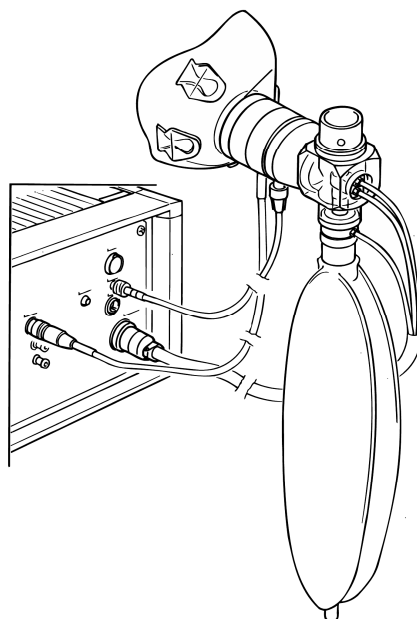



Performing a Cardiac Output test

1. Select **Execute Test** from the **Test** menu or press **F2** and start the test as for an ergometry test.
2. During the desired phase (rest or exercise), in a steady state, select **Cardiac Output** from **Test/Event...** menu.
3. By using the corresponding buttons of the Toolbar prepare the bag by refilling it starting from completely collapsed (otherwise the initial concentration of CO₂ will be lower than expected value and the results could be unreliable).
4. Connect the valve assembly to the output port of the turbine flowmeter trying not to affect too much the performance of the patient.
5. At the end of the expiration press **F2** to start the rebreathing.
6. Stop the test by pressing **F3** when the equilibrium is reached or wait for the automatic interruption after 20 seconds from the beginning of the rebreathing.
7. Close the Cardiac output event with the corresponding button on the Toolbar.

Note: The values of VO₂, VCO₂ and R during the rebreathing and in the following 2 minutes are not reliable because of the high concentration of CO₂.

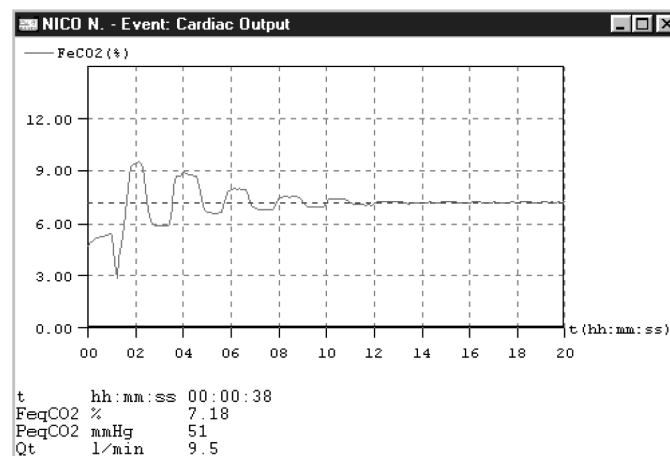

Flow Volume loops

This test is useful during exercise to detect abnormalities in the mechanics of ventilation in patients with pulmonary/ventilatory limitations to exercise.

The test consists in acquiring some flow/volume loops during exercise at different workloads and overlapping them on the rest maximal flow/volume loop of a Forced Vital Capacity test.

The major information that you can get from this manoeuvre are the flow reserve (flow distance from the peak flow of the F/V loop during exercise to the corresponding flow on the superimposed F/V loop at rest) and the volume reserve (volume distance from the maximum volume of the F/V loop during exercise to the corresponding volume on the superimposed F/V loop at rest).

The manoeuvre consists in the following phases:

- Acquiring some Flow/Volume loops during the exercise
- Making the patient inspire completely up to TLC level (this is necessary to place the loop correctly into the rest F/V loop of the forced Vital Capacity test)
- Overlapping the F/V loop acquired during exercise and the F/V loop performed at rest.

Flow Volume loop during the test

1. Start with normal Exercise test and begin the memorisation of breath values (**F2**)
2. During a steady state select **F/V loops** from **Test/Event...**
3. As soon as 2 or 3 complete loops have been acquired ask the patient to inspire completely up to TLC level and press **F3** to stop the acquisition.



O2, CO2 vs Time

The O2, CO2 event is useful to check the real-time readings of the O2 and CO2 signals during the test.

O2, CO2 vs Time during the test

1. Start with normal Exercise test and begin the memorisation of breath values (F2)
2. During a steady state select **O2, CO2 vs Time** from **Test/Event...**
3. As soon as 5 or 6 complete breaths have been acquired press **F3** to stop the acquisition.

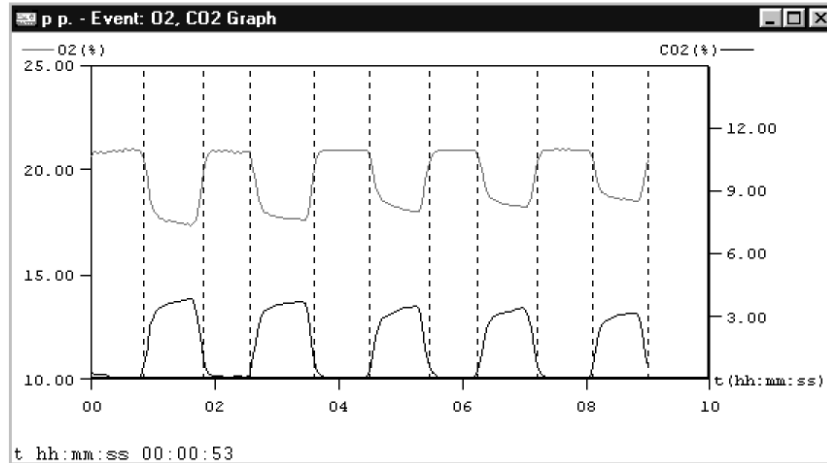

O2 Saturation (optional)

The O2 Saturation event is useful to check the quality of SpO2 signal acquired by the on-board Oxymeter (if available) during the test.

O2 Saturation during the test

1. Start with normal Exercise test and begin the memorisation of breath values (F2).
2. Select **O2 Saturation** from **Test/Event...**
3. As soon as 5 or 6 complete pulses have been acquired press **F3** to stop the acquisition.

Spirogram

The spirogram event allows to display and store the volume/time plot.

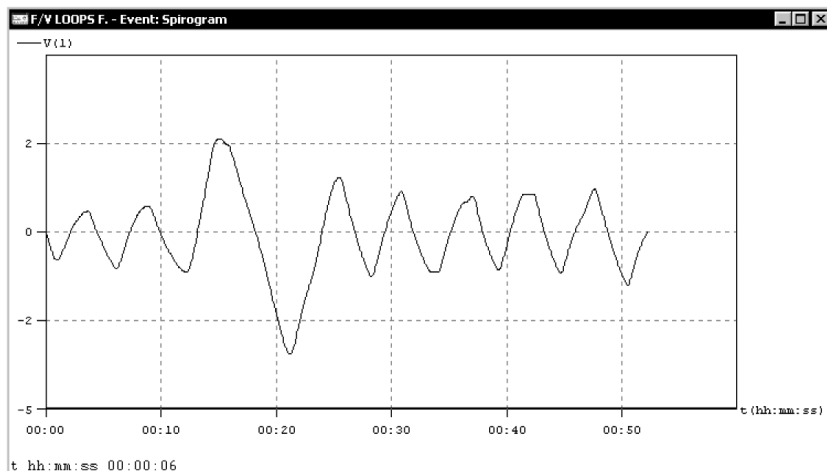

Spirogram during the test

1. Start with normal Exercise test and begin the memorisation of breath values (F2).
2. During a steady state select **Spirogram** from **Test/Event...**
3. Acquire volume/time plot until the window is filled and press **F3** to stop the acquisition.

View the events after the test

1. Select **Data...** from the **View** menu
2. Select the test during which spirogram event has been carried out in the list box and press **OK**
3. Select **View...** from the **Events** menu, choose the desired event and press **OK**.
4. Select **Print Current Window...** from the **File** menu to print the F/V curve page.

It is possible to edit the F/V loops event in the following way:

5. Select **Edit...** from the **Event** menu to change the F/V loop at rest (the list contains all the FVC test carried out by the same Patient with the Spirometry software) and press **OK**.

It is possible to edit the Cardiac Output event in the following way:

5. Select **Edit...** from the **Event** menu to change the parameters measured during the steady state before the rebreathing, the CO₂ concentration at the equilibrium and the calculation method.

Raw data

It's a particular feature with which the user can check and save some parameters (CO₂ output, O₂ concentration and volumes) in Ascii file format in a archive apart at a sampling rate of 25 Hz.

Save Raw data

1. During the test choose **Event** from **Events** menu.
2. Select Raw Data from the list.
3. On the save data box give a name to the file and select the destination folder.
4. To stop saving Raw data press the **stop** icon or press **F3** on the keyboard.



Resting Metabolic Rate Test

--

Metabolism

Metabolism can be understood as the conversion by the human body between food and accumulated fat into energy. The energy is used by the body to maintain constant temperature, to move and to make all the organ function. Measure of metabolism is: calories (cal).

Total Metabolic Rate

The total metabolic rate are the total calories that the human body needs in order to actuate the daily functional activities.

Resting Metabolic Rate (RMR)

Resting Metabolic Rate represents the calories that the vital organs need to properly operate at rest (heart, brain, lungs, liver, kidneys etc.). RMR represents between 60% and 75% of the human's total metabolism.

Importance to measure RMR

A knowledge of the RMR is very helpful in order to understand the nutritional needs and to properly manage it.

Measure of the rest metabolic rate with indirect calorimetry

Energy expenditure can be measured directly by putting a person in a calorimeter and measuring the amount of heat produced by the body mass.

This is expensive and very impractical in the clinical setting. Energy expenditure can be measured indirectly with a metabolic cart by analysis of respired gases (usually expired) to derive volume of air passing through the lungs, the amount of oxygen extracted from it (i.e., oxygen uptake VO_2) and the amount of carbon dioxide, as a by-product of metabolism, expelled to atmosphere (CO_2 output – VCO_2). With these measurements the resting energy expenditure (RMR) and respiratory quotient (RQ) can be calculated.

The RQ represents the ratio of carbon dioxide exhaled to the amount of oxygen consumed by the individual. RQ is useful in interpreting the results of the RMR. The abbreviated Weir equation is probably the most common calculation of RMR.

Abbreviated Weir equation:

$$RMR = [3.9 (VO_2) + 1.1 (VCO_2)] 1.44$$

How to perform a RMR test

For best results, when having a REE done, there are certain conditions that need to be controlled and others that just require documenting at the time of the test. During the test the individual is interfaced with a metabolic measurement system by means of a facemask.

A mouthpiece with a nose clip is also sometimes used, but it may create overly stressful conditions to a subject (patient).

Important considerations or conditions to improve the RMR measurement:

- No food for at least 12 hours and no smoke for at least 2 hours before the test.
- Maintain quiet surroundings when the test is in progress and normal temperature. The individual should not move arms or legs during the test.
- Medications taken should be noted, such as stimulants or depressants.
- The first 5 minutes of acquisition should be discarded by the computation of RMR
- Steady state should be achieved, which would be identified clinically by the following criteria: 5 minute period when average minute VO_2 and VCO_2 changes by less than 10%, average RQ changes by less than 5%
- Stable interpretable measurements should be obtained in a 15 to 20 minute test.
- Renal failure patients requiring hemodialysis should not be tested during dialysis therapy.

Recommendations

Before starting an RMR test, it is necessary to select and calibrate the turbine used. Read carefully the calibration procedure, in the *Calibration* chapter.

Resting metabolic rate test using the face mask

Use the following correction for the dead space (VD):

- 50 ml for the small mask
- 60 ml for the medium mask
- 70 ml for the large mask

Resting metabolic rate test using the canopy option

1. Verify (before and during the test) that the FeCO_2 falls within the range 0.7%-1.3% and adjust the flow rate of the pump as necessary. If the FeCO_2 is too low you should decrease the flow rate and if the FeCO_2 is too high you should increase the flow rate. A low FeCO_2 may result in unreliable measurements, while a high FeCO_2 could be dangerous for the patient.
2. Do not place Canopy hood over a patient's head before the tube is properly connected and a continuous flow is applied from Canopy Blower.

Performing a test using the face mask

Calibrations

Before the test, it is necessary to perform an ergo calibration (see Calibration chapter) and it is advisable to perform also a turbine calibration (see Recommendations in this chapter).

How to prepare a patient

The patient interfaces with the equipment by means of a face mask, as depicted in the following image. The mask has to be tight to the face, in order to avoid any air leakage.

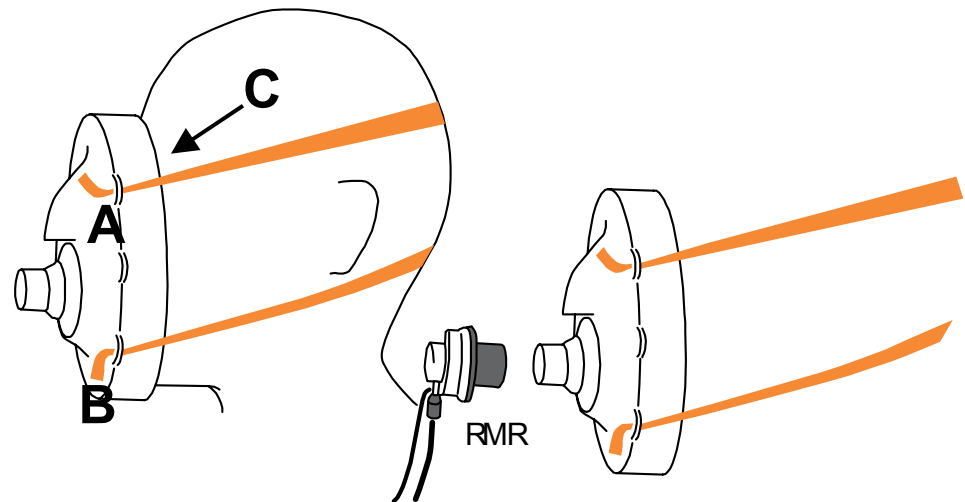

Make sure that the subject health status is acceptable according to what stated in the guidelines.

Make the subject sit or lay on a comfortable chair or bed.

Fix the mask to the subject, as illustrated in the above picture, pull the elastic strings (Point A and B) accurately in order to eliminate possible leaks. The mask must be perfectly sealed to the face of the subject, especially in correspondence with the nose (point C).

The mask adapt differently according to the face shape of the subject. The perfect position is therefore to be determined from subject to subject.

Start the test



1. Enter in the ergometry program
2. Select a patient or add a new one (**File/Patients...**)
3. Select **Start test** from **Test** menu

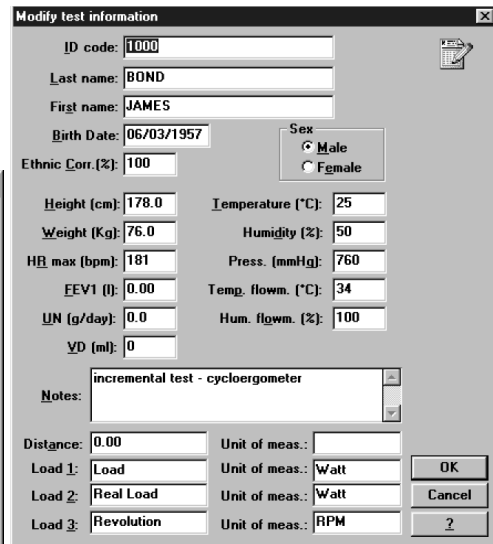
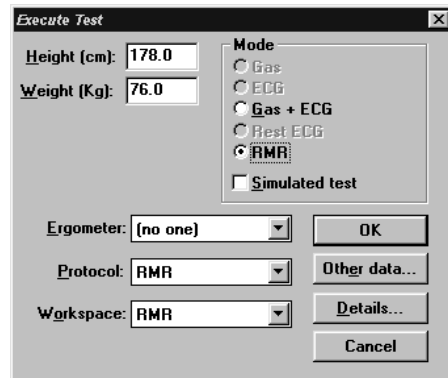

4. Enter the patient's data and select the **RMR** mode (1st picture).
5. Press **Other Data...** and enter the dead space value (50ml Small mask, 60ml Medium mask and 70ml Large mask). It is possible to enter the Ureic Nitrogen value NU (2nd picture).
6. Confirm and start the test by pressing **OK**.

Selecting **RMR** the system set automatically the following options:

- Data acquisition with a 30 seconds average
- RMR protocol, which is:
 - 5 minutes discarded;
 - 10 minutes with data acquisition, of which the software will make an average at the end of the test;
 - automatic end of the test after the 16th minute.
- Selection of the RMR workspace (windows placement);

The test is fully automatic, the software will stop it and save the data at the end of the 16th minute.

The real time view is as shown in the following picture:

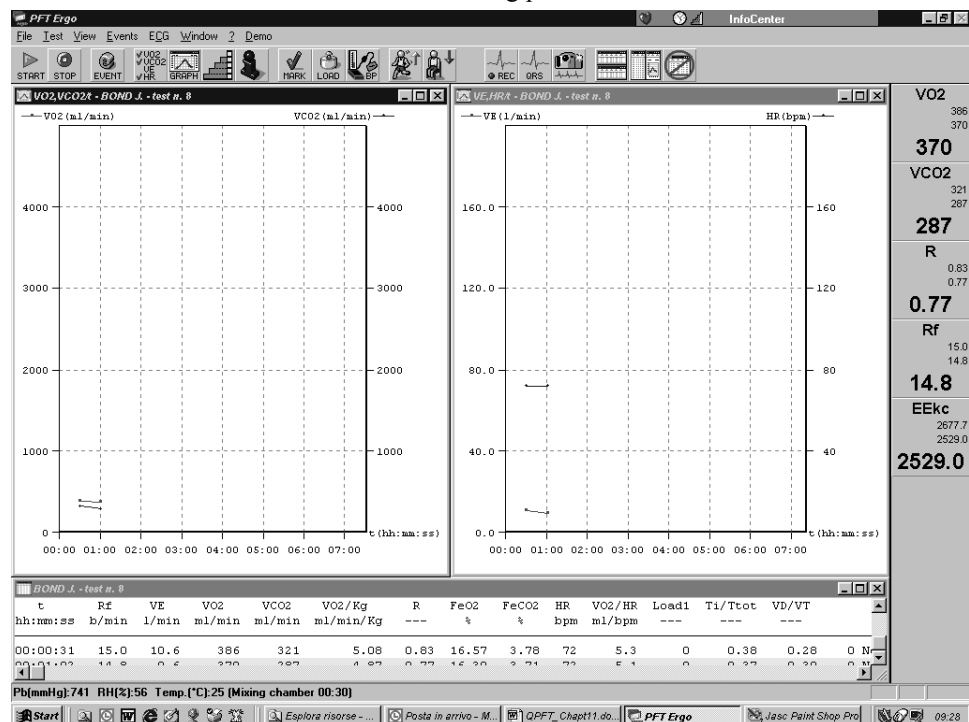

Viewing the test

At the end of the test, it will be opened automatically a window with the test results.

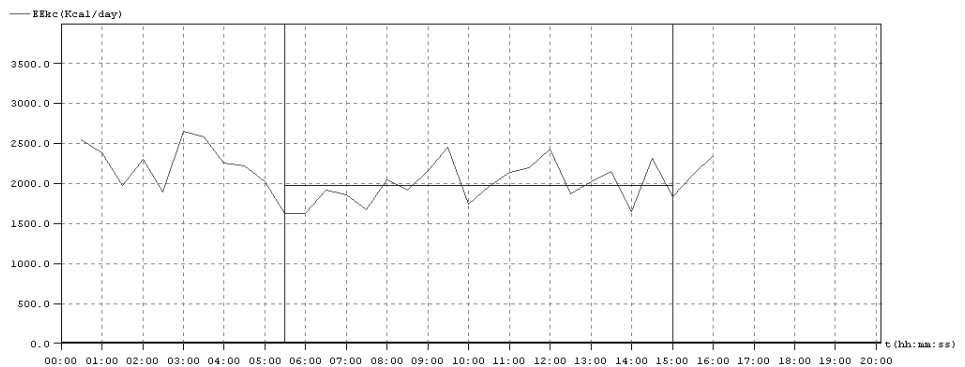
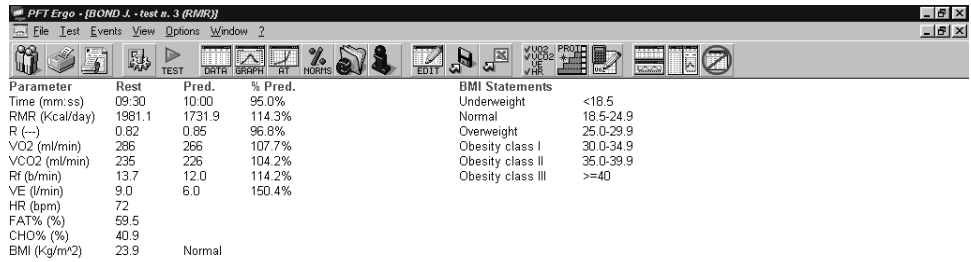

At the end of the test, or if it is selected **View/RMR**, the main results are shown:

- The average time interval (default: 10 minutes)
- Average values of VO₂, VCO₂, R, RMR, RF, VE, HR, FAT% and CHO% and predicted values if available.
- Body Mass Index (BMI) and interpretation
- Graph of the energetic expenditure for all the data acquisition interval, highlighting the selected average interval.

In order to verify the goodness of the test, check that the ventilation and respiratory frequency are similar to the predicted ones (12 breaths/min for the respiratory frequency and 6 litres/min for the ventilation), and the heart rate is the rest heart rate of the patient.



Nota: The percentage of used Proteins (PRO%) is calculated assuming 12 grams of Ureic Nitrogen in 24 hours. You can modify this value selecting **View/Information...** -> **Modify...**

How to modify the average interval

If the average interval (automatically identified by the software) is not satisfying, for example because the patient was speaking in the first minutes, it is possible to modify the interval of the average.

Right-click and select **Edit RMR...** It is possible to move the start and the end lines.

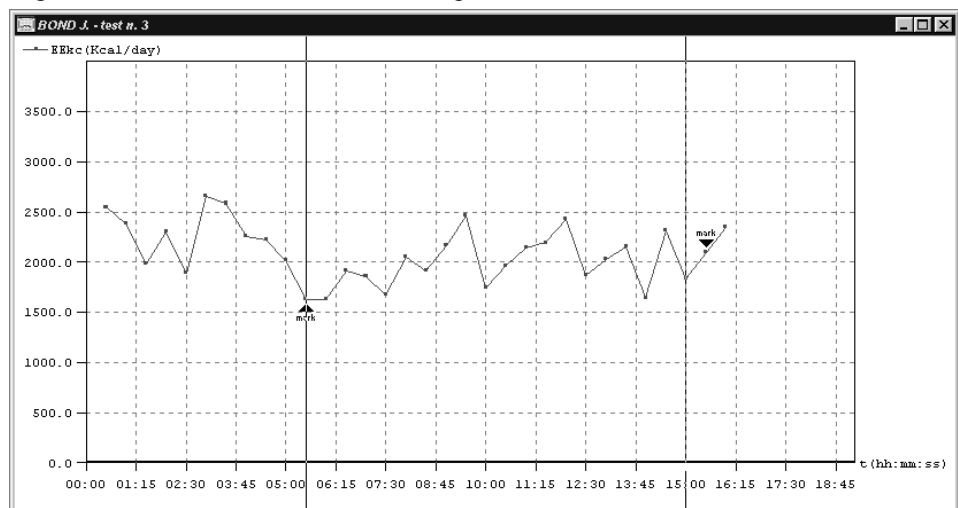

To move the start line, left-click on the exact time in which you want to start the calculations, for the end line, right-click.

The print of the current window generates a report similar to the one in the following page.



COSMED s.r.l.
P.O. BOX 3, 00040 Rome, Italy
tel: +39-069315492; fax: +39-069314580
http://www.cosmed.it; E-mail: info@cosmed.it

Last name: **BOND** First name: **JAMES** ID code: **1000** Barometric press. (mmHg): **737**
 Test number: **3** Test date: **13/03/1997** Temperature (degrees C): **27**
 Sex: **M** Test time: **00:00** STPD: **0.799**
 Age: **40** N. of steps: **32** BTFS insp: **1.087**
 Height (cm): **178.0** Duration (hh:mm:ss): **00:16:00** BTFS exp: **1.020**
 Weight (Kg): **76.0** BSA (m²): **1.9** BMI (Kg/m²): **23.9**
 HR max (bpm): **180**

Notes:

Constant Load Exercise - cycloergometer

Parameter	Rest	Pred.	% Pred.
Time (mm:ss)	09:30	10:00	95.0%
RMR (Kcal/day)	1981.1	1731.9	114.3%
R (---)	0.82	0.85	96.8%
VO2 (ml/min)	286	266	107.7%
VCO2 (ml/min)	235	226	104.2%
Rf (l/min)	13.7	12.0	114.2%
VE (l/min)	9.0	6.0	150.4%
HR (bpm)	72		
FAT% (%)	59.5		
CHO% (%)	40.9		
BMI (Kg/m ²)	23.9	Normal	

BMI Statements

Underweight	<18.5
Normal	18.5-24.9
Overweight	25.0-29.9
Obesity class I	30.0-34.9
Obesity class II	35.0-39.9
Obesity class III	>=40

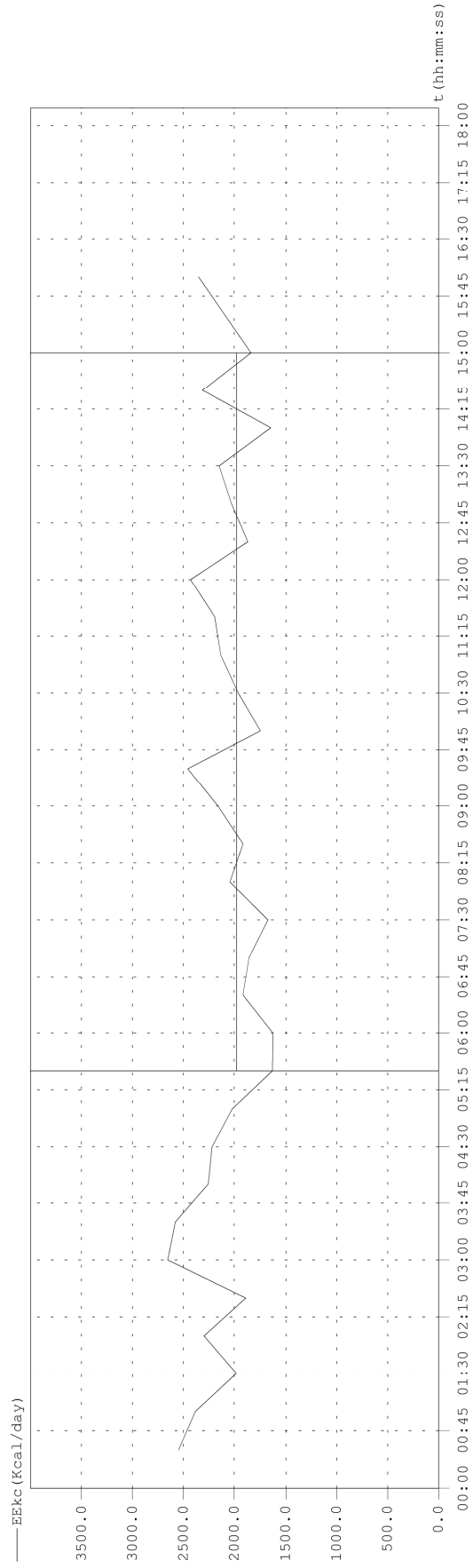

Performing a test using the canopy option

The principle of a ventilated bubblehood system is that a stream of air is forced to pass across the face of a subject and mixes with the air which is collected by a transparent hood, placed over the subject's head. A measurement system, knowing the flow rate, calculates the oxygen consumption and the CO₂ production and, starting from these values, the energy expenditure.

Calibrations

Before the test, it is necessary to perform an ergo calibration (see *Calibration* chapter) and it is advisable to perform also a turbine calibration (see *Recommendations* in this chapter).

How to prepare the canopy and the patient

Replacement of the power plug

If the power plug does not fit into the mains socket, replace it with the one in the packaging.

In order to replace the plug:

1. Extract the plug from the battery charger
2. Insert the proper plug in the battery charger.

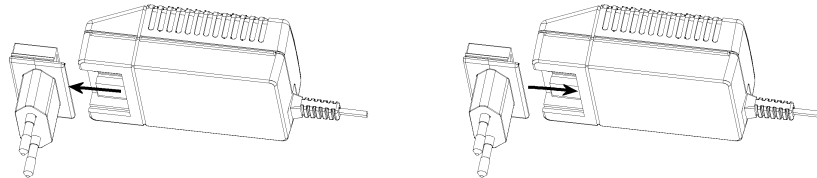

Connecting the Canopy

1. Connect the Canopy unit to the mains by means of the medical grade AC/DC adapter provided.
2. Fix the vail to the bubblehood through the velcro strips.
3. Insert the bubblehood adapter into the bubblehood from the outside and fix it screwing the ring from the inside, being careful to insert it in the proper hole, as shown in the following picture.

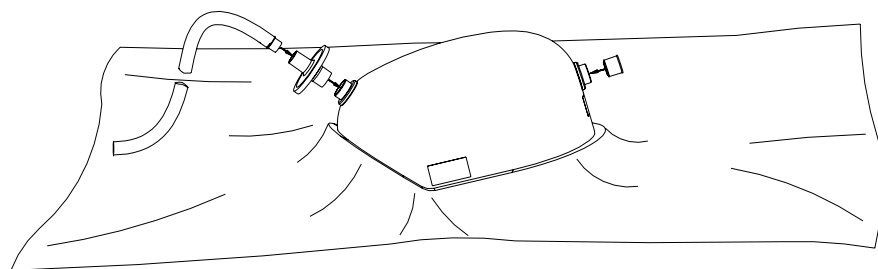

4. Connect the bubblehood to the wrinkled tube, interposing a bacterial filter.
5. Connect the wrinkled tube to the unit through the *Flow in* connector.
6. Connect the optoelectronic reader of the K4 b² to the *Flow out* connector of the Canopy unit.



How to prepare the patient

1. Switch on the Canopy unit. If there are no problems, the red led on the front panel of the unit flashes for few seconds and the alarm beeps. If the led does not flash and/or the alarm does not beep, the test cannot be performed, because the backup battery is exhausted or there is no backup battery.
2. When the green led turns on, the test can start. If the green led does not turn on, the red led flashes and the alarm beeps, the test cannot be performed because the pump does not work or the mains does not power the system.
3. After these checks, put the patient in a supine position.
4. Place the bubblehood with the vail on the patient's head. The tube has to be placed near the patient's mouth.

Warning! Do not place Canopy hood over a patient's head before the tube is properly connected and a continuous flow is applied from Canopy Blower.



Performing the test



1. Enter in the ergometry program
2. Select a patient or add a new one (**File/Patients...**)
3. Select **Start test** from **Test** menu.

Execute Test

Height (cm): 180
Weight (Kg): 80

Ergometer: (no one)
Protocol: RMR
Workspace: RMR

Mode:
 Gas
 ECG
 Gas + ECG
 Rest ECG
 RMR
 Canopy
 Simulated test

OK
Other data...
Details...
Cancel

4. Enter the patient's data and select the **Canopy** mode.
5. Confirm and start the test by pressing **OK**.
6. In the first part of the test the flow rate of the pump has to be adjusted by means of the *Flow adjustment* handle on the front panel of the Canopy unit, in order to measure an FeCO₂ between 0.7% and 1.3%. FeCO₂ values can be read on the right side of the PC monitor.
7. When the FeCO₂ remains within the acceptability range, press **F2** to start the data acquisition. Verify, also during the test, that the measured FeCO₂ is within the 0.7%-1.3% range. Otherwise, adjust it by means of the *Flow adjustment* handle.

Warning: *If the green led turns off during the test, the red led flashes and the alarm beeps, abort the test, because the pump does not work or the mains does not power the system. In the last case, the pump works only because of the backup battery.*

The test is fully automatic, the software will stop it and save the data at the end.

Viewing the test

At the end of the test, it will be opened automatically a window with the test results.

At the end of the test, or if it is selected **View/RMR**, the main results are shown:

- The average time interval (default: 10 minutes)
- Average values of VO_2 , VCO_2 , R, RMR, VE, HR, FAT% and CHO% and predicted values if available.
- Body Mass Index (BMI) and interpretation
- Graph of the energetic expenditure for all the data acquisition interval, highlighting the selected average interval.



Note: *The percentage of used Proteins (PRO%) is calculated assuming 12 grams of Ureic Nitrogen in 24 hours. You can modify this value selecting View/Information... ->*

Modify...

In order to verify the goodness of the test, check that the FeO_2 and FeCO_2 values are within the acceptability ranges (20.2%-20.8% and 0.5%-0.8% respectively), and the heart rate is the rest heart rate of the patient.

How to modify the average interval

If the average interval (automatically identified by the software) is not satisfying, for example because the patient was speaking in the first minutes, it is possible to modify the interval of the average.

Right-click and select **Edit RMR...** It is possible to move the start and the end lines.

To move the start line, left-click on the exact time in which you want to start the calculations, for the end line, right-click.

Print

The print of the current window generates a report similar to the one of the RMR test using the face mask.

Sub-maximal Exercise Testing

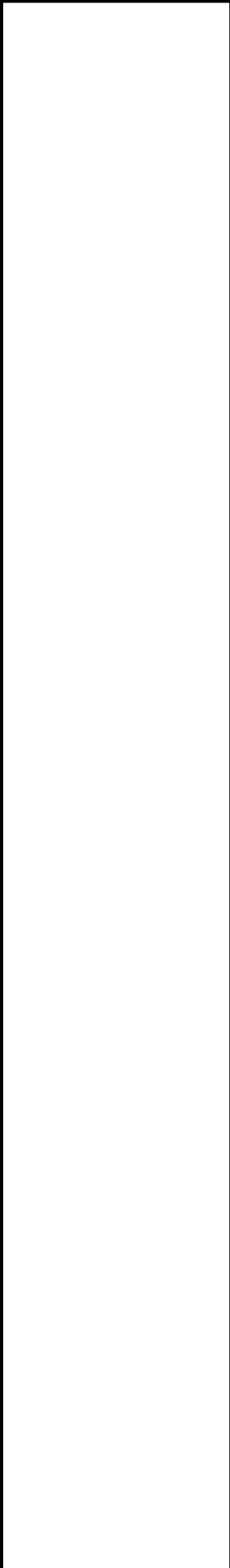

Introduction

Several physiological responses to exercise are used to evaluate cardiorespiratory fitness, including oxygen consumption, heart rate, and blood pressure. Measuring these variables during exercise, particularly maximum exercise, increase the chance of detecting any coronary artery disease or pulmonary disease.

Unfortunately, maximum exercise tests are impractical because they are expensive, require extensive clinical supervision, and subject individuals to levels of physical stress that may be unnecessary depending on the objectives of the test. Consequently, maximal testing is reserved for clinical assessments, athletic evaluation, and research.

A sub-maximal exercise test costs less and carries a lower risk for the individual. Although less sensitive and specific for detecting disease or estimating maximal oxygen consumption, correctly performed sub-maximal tests can provide a valid estimate of cardiorespiratory fitness.

Pre-test screening

Pre-test health screening is essential for risk stratification and for determining the type of test that should be performed and the need for an exercise test prior to exercise training. A thorough pretest health screening includes the following:

- Complete medical history
- Medical contraindications to exercise
- Symptoms suggesting cardiac or pulmonary disease
- Angina or other forms of discomfort at rest or during exercise
- Unusual shortness of breath at rest or during exercise
- Dizziness or light-headedness
- Orthopaedic complications that may prevent adequate effort or compromise the validity of test results
- Other unusual signs or symptoms that may preclude testing
- Risk factors for coronary heart disease
- History of major cardiorespiratory events
- Current medications
- Activity patterns
- Nutritional habits
- Reading and signing an informed consent form

Sub-maximal exercise testing

Heart rate varies linearly with VO_2 to the point of maximum exertion; thus, VO_{2max} may be estimated using the relation between heart rate and VO_2 without subjecting the individual to maximum levels of physical stress. During sub-maximal exercise testing, predetermined workloads are used to elicit a steady state of exertion (plateau of heart rate and VO_2). The steady-state heart rate at each work level is displayed graphically and extrapolated to the VO_2 at the age-predicted maximal heart rate ($HR = 220 - \text{age}$). A variety of protocols for different exercise modalities (i.e., treadmill, stationary cycle, and step increments) can be used as long as the VO_2 requirements of each selected workload can be estimated with accuracy.

The objectives of cardiorespiratory fitness assessments in the apparently healthy population are as follows:

- Determine the level of cardiorespiratory fitness and establish fitness program goals and objectives.
- Develop a safe, effective exercise prescription for the improvement of cardiorespiratory fitness.
- Document improvements in cardiorespiratory fitness as a result of exercise training or other interventions.
- Motivate individuals to initiate an exercise program or comply with an established program.
- Provide information concerning health status.

A few assumptions regarding testing are necessary to ensure the highest degree of accuracy when using sub-maximal exercise testing to estimate VO_{2max} :

- Selected workloads are reproducible. A steady-state heart rate is obtained during each stage of the test. Usually, workload durations of 3 minutes or more are used to ensure steady state.
- The maximal heart rate for a given age is uniform ($HR = 220 - \text{age}$).
- Heart rate and VO_2 have a linear relation over a wide range of values; thus, the slope of HR/VO_2 regression can be extrapolated to an assumed maximum heart rate.
- Mechanical efficiency (i.e., VO_2 at a given work rate) is consistent.

Although if done correctly, sub-maximal exercise tests provide valuable information concerning cardiorespiratory fitness, they have extremely limited diagnostic capabilities and should not be used as a replacement for clinical exercise tests or other clinical treatment or management modalities. Health care professionals should avoid detailed interpretation beyond the scope of the information obtained.

Considerations with sub-maximal exercise testing

Considerations for selection of protocol and equipment include any physical or clinical limitations that may preclude certain types of exercise (i.e., age, weight, arthritis, orthopaedic complications, individual comfort, level of fitness, type of exercise training that will be performed, and individual preference).

For example, some individuals may perform better on a non-weight-bearing modality (cycle versus treadmill), while others may not have the required range of motion in the hip or knee to pedal and may perform better walking. Deconditioned, weak, or elderly persons may have to start the test at a low work level and increase the workload in small increments. Also, field tests may not be appropriate for those who require strict supervision during testing, who do not understand the concept of pacing, or who cannot be expected to put forth a good effort. More consistent results may be obtained by testing in a controlled environment such as a laboratory setting. Creativity when selecting protocols may allow adaptations of commonly used protocols to accommodate athletes competing in specific sports. Regardless of the type of exercise and protocol selected, the same type of exercise and protocol should be used for repeat testing if between-test comparisons are important.

Staffing

Staff members should be able to do the following:

1. Establish rapport with the subject and make him or her feel comfortable.
2. Recognize normal acute and chronic responses to exercise.
3. Recognize abnormal signs and symptoms during exercise.
4. Provide basic life support measures competently.
5. Adhere to established procedures and protocols.
6. Clearly explain test results to the individual.

Test termination

Sub-maximal tests should be terminated according to ACSM or other accepted guidelines (see table in the following). In the event of an abnormal response, the test should be terminated, the medical director of the facility and the individual's primary care physician notified, and all specified follow-up procedures performed. In the event of mechanical or electrical failure that may compromise the accuracy of the test results or monitoring capabilities, the test should be terminated until the problem is corrected.

General Indications for Stopping an Exercise Test in Apparently Healthy Adults

Onset of angina or angina-like symptoms

Significant drop (20 mmHg) in systolic blood pressure or a failure of the systolic blood pressure to rise with an increase in exercise intensity

Excessive rise in blood pressure: systolic pressure >260 mmHg or diastolic pressure >115 mmHg

Signs of poor perfusion: tight-headedness, confusion, ataxia, pallor, cyanosis, nausea, or cold and clammy skin

Failure of heart rate to increase with increased exercise intensity

Noticeable change in heart rhythm

Subject requests to stop

Physical or verbal manifestations of severe fatigue

Failure of the testing equipment

Assuming that testing is non-diagnostic and is being performed without direct physician involvement or electrocardiographic monitoring.

Considerations for accuracy

The ability to obtain valid and reproducible results is essential to ensure that any differences between pre-treatment and post-treatment test results are due to exercise training rather than variations in testing procedures. Some inconsistencies that are inherent may increase variability:

- Sub-maximal heart rate is influenced by time of day, eating, smoking, and familiarization with test procedures.
- Prediction equations for estimating $\text{VO}_{2\text{max}}$ may overestimate trained individuals and underestimate untrained individuals.
- The efficiency of motion during walking, running, and cycling varies.
- Cardiac output and VO_2 have a test-retest variability of 3-4%.

Psychological factors, such as pre-test anxiety, may influence the heart rate, especially at rates below 120 beats per minute and at low workloads. It is not unusual for the heart rate and/or blood pressure to be higher at rest than during the initial stages of exercise in these cases. Having the subject repeat the first test may improve reliability, particularly if the subject has never previously performed such a test.

Factors that can cause variation in the heart rate response to testing:

- Dehydration
- Prolonged heavy exercise prior to testing
- Environmental conditions (e.g., heat, humidity, ventilation)
- Fever
- Use of alcohol, tobacco, or caffeine 2 to 3 hours prior to testing

Because of these inherent inconsistencies, standard procedures for each test must be strictly followed to ensure the greatest accuracy and reproducibility possible:

- Standard testing protocol
- The same testing modality and protocol for repeat testing
- A constant pedal speed throughout cycle ergometry testing
- Cycle seat height properly adjusted, recorded, and standard for each test
- The time of day for repeat testing consistent
- All data collection procedures standardized and consistent
- Test conditions standard
- Subjects free of infection and in normal sinus rhythm
- Prior to the test, no intense or prolonged exercise for 24 hours, smoking for 2-3 hours, caffeine for 3 hours, or heavy meal for 3 hours
- Room temperature 18-20°C (64-68°F) with air movement provided

Performing the test

In this chapter it is supposed that the user is able to:

- perform an exercise test
- create exercise protocols
- view, edit and print tests

If this is not the case, please read the *Exercise testing* chapter.

To perform a sub-maximal test, follow these instructions:

1. Create a proper protocol (procedural guidelines for several sub-maximal testing protocols are provided in [ACSM's Guidelines for Exercise Testing and Prescription, 6th Edition Philadelphia: Williams&Wilkins, 2000:22-29]).
2. Start an exercise test.
3. Perform the test as it were a maximal exercise test, ending it when the heart rate reaches the 85% of the Hrmax, or it happens an event listed in the section *Test termination*.
4. Display a VO₂/Kg vs. HR plot
5. Right-click on the graph and select **VO₂ submax** from the pop-up menu.

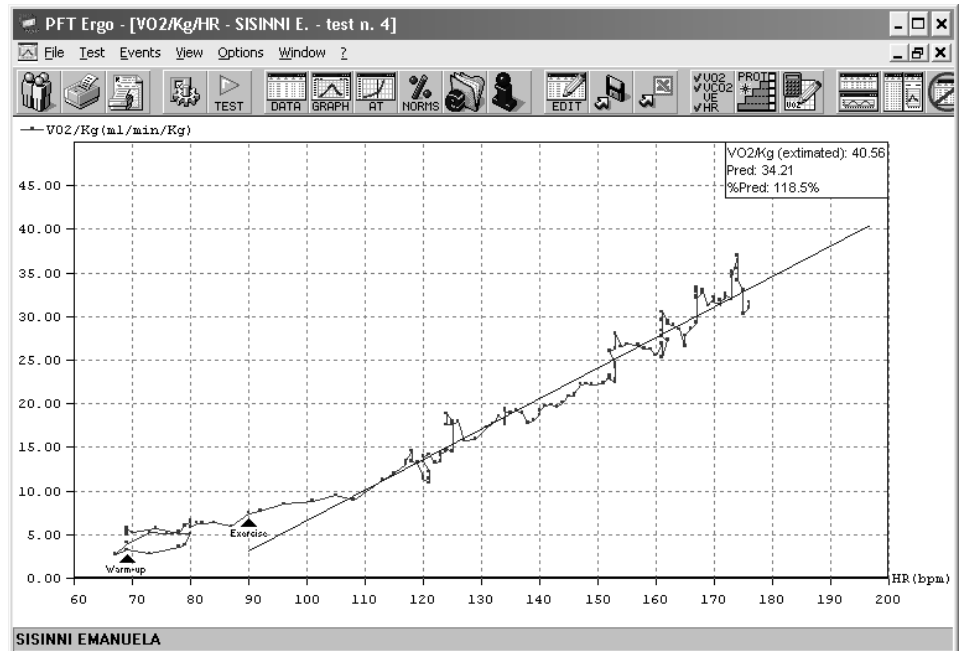

If the predicted HR max (calculated as 220-age) is not suitable for the patient tested, it is possible to edit the HR max value from the **View/Information...** page.

An example of testing protocol

An example of protocol is reported here. The YMCA cycle ergometry protocol is defined as follows.

1st step: workload 150 kgm/min

2nd step: if the HR at the end of the 1st step is:

<80	80-89	90-100	>100	
set the workload at (kgm/min)	750	600	450	300

3rd step: if the HR at the end of the 2nd step is:

<80	80-89	90-100	>100	
set the workload at (kgm/min)	900	750	600	450

4th step: if the HR at the end of the 3rd step is:

<80	80-89	90-100	>100	
set the workload at (kgm/min)	1050	900	750	600

The mixing chamber

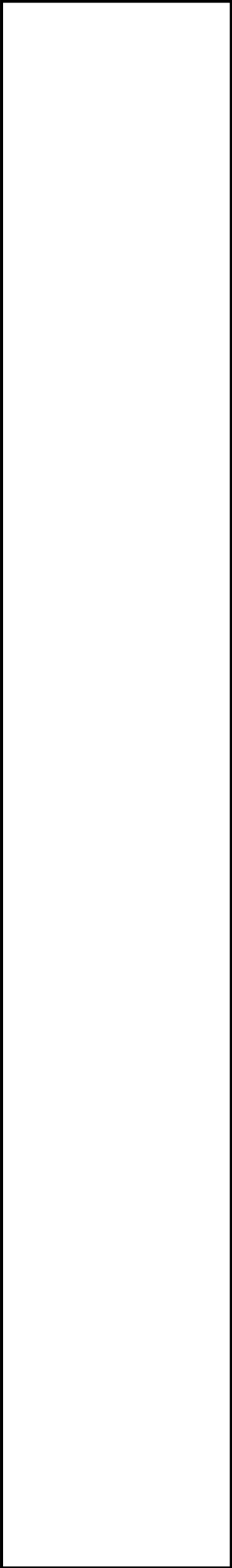

The mixing chamber

Overview

The mixing chamber is a 7-litres plexiglas box, for exercise or resting ($VE < 40$ l/min) tests. For resting tests only a part (about 2.3 litres) of the mixing chamber is used.

The mixing chamber is shown in the following picture:

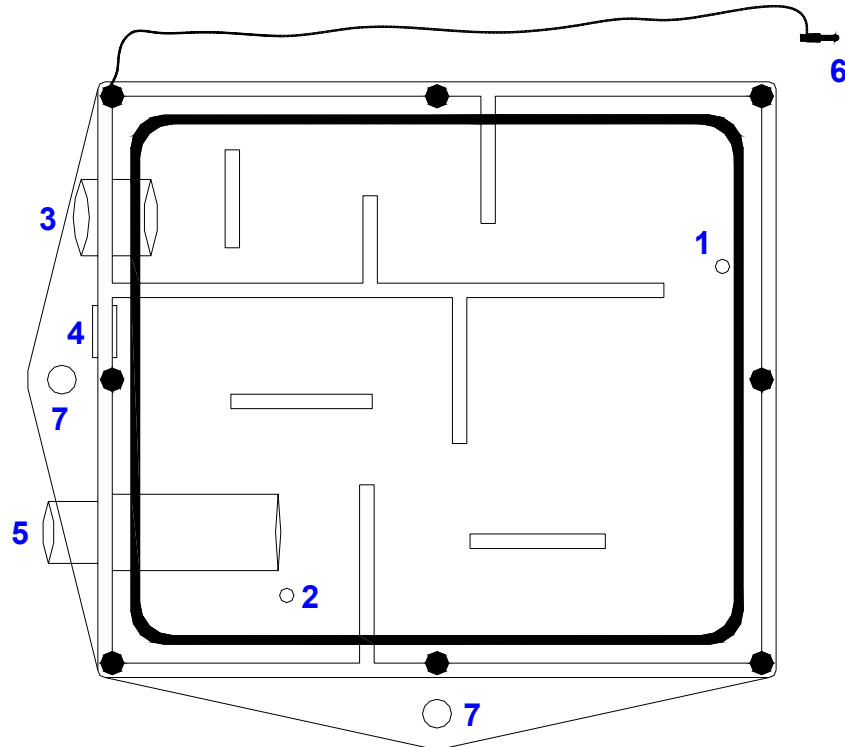

1. Connector for the sampling line, for resting tests or tests with $VE < 40$ l/min.
2. Connector for the sampling line, for exercise tests or tests with $VE > 40$ l/min.
3. Inlet for patient's exhaled air.
4. Connector to be closed with the proper plug supplied with the equipment.
5. Outlet for patient's exhaled air.
6. Little plug for closing the connectors #1 or #2.
7. Fixing holes.

Preparing the mixing chamber for a test

1. Connect the wrinkled tube to the inlet #3 of the mixing chamber.
2. Connect the turbine to the outlet #5 of the mixing chamber.
3. Disconnect the sampling line from the turbine and connect it to the connector #1 (for resting tests) or #2 (for exercise tests) of the mixing chamber.
4. Close the connector #2 (for resting tests) or #1 (for exercise tests) of the mixing chamber with the little plug #6.
5. Close the connector #4 with the proper plug supplied with the equipment.

Two-way non rebreathing valve description

The two-way non rebreathing valve is very important in order to perform the test properly. It is shown in the following picture:

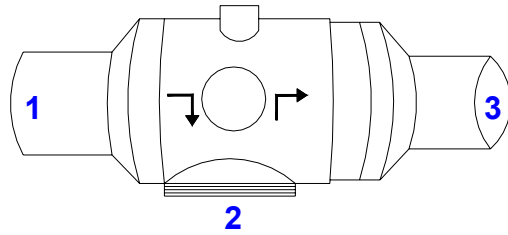

1. Valve inlet
2. Connector for the mask
3. Valve outlet

Note: be very careful in order to differentiate inlet from outlet. These two are not interchangeable, to guarantee proper functionality.

Patient's preparation

1. Screw the mask to the connector #2 of the valve.
2. Connect the wrinkled tube to the outlet #3 of the valve.
3. Fix the mask as illustrated in the picture below. Adjust the elastic bands on the head cap as necessary to eliminate possible leaks and create a tight seal around the subject's face.

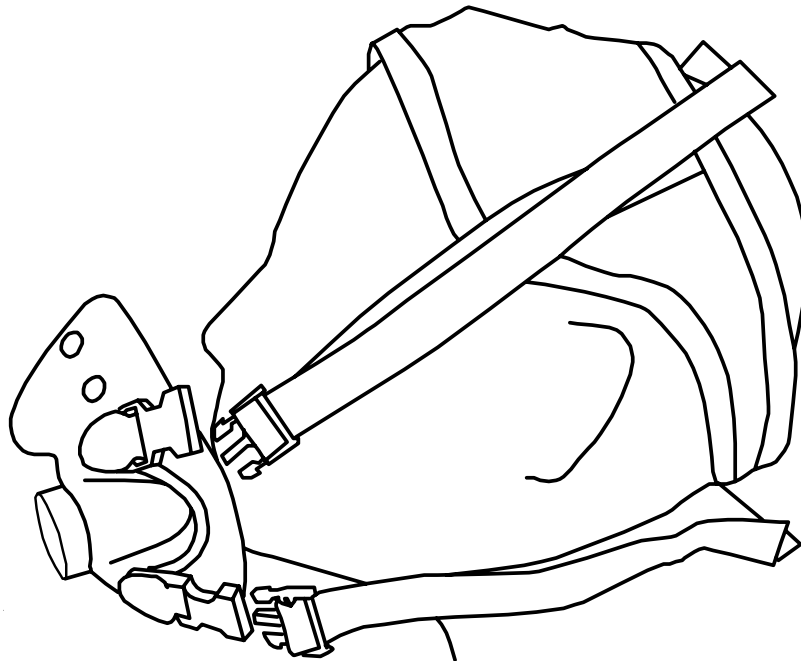

4. Complete the patient preparation as indicated in the chapter *Exercise testing*.

Performing the test

1. Calibrate the analyzers as described in the Calibration chapter
2. Select **Test/Execute Test** or press the icon  or press **F2**.
3. Select **Mixing chamber** in the *Execute test* window and perform the exercise/resting test as illustrated in the chapter *Exercise testing*.



Spirometry

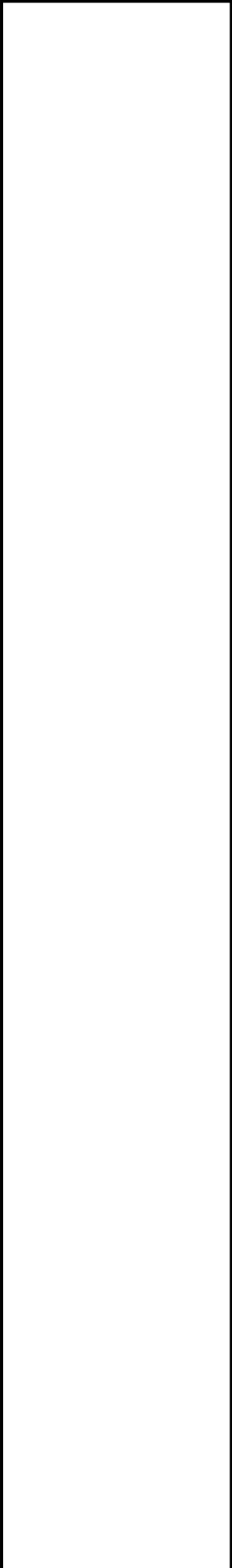

Setting spirometry options

The software allows to configure some options selecting **Configure** from the **Option** menu.

Spirometry

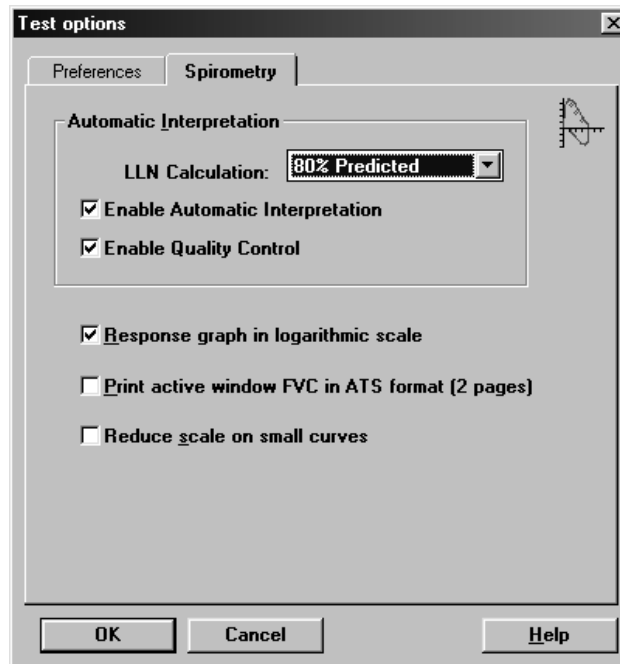

Automatic Interpretation

Quark b² has the function of interpreting each test performed by a patient visualising an automatic diagnosis. The algorithm has been calculated basing on “Lung Function Testing: selection of reference values and interpretative strategies, A.R.R.D. 144/1991:1202-1218”.

The automatic diagnosis is calculated at the end of the FVC Test if:

- the automatic diagnosis option is enabled.
- the patient’s anthropometric data allow the calculation of the LLN (Lower Limit of Normal range).
- at least one FVC test has been performed.

To enable/disable the automatic diagnosis:

1. Click on **Enable Automatic Interpretation** checkbox to enable or disable the calculation and the visualisation of the automatic interpretation.
2. Select the LLN (Lower Limit of Normal Range) criteria among the ATS (LLN=Pred-0.674*SD), ERS (LLN=Pred-1.647*SD) or 80%Pred (LLN=Pred*0.8) specifications.

Quality control

Quark b² allows a quality test control. The calculation has been carried out referring to “Spirometry in the Lung Health Study: Methods and Quality Control, A.R.R.D. 1991; 143:1215-1223”. The messages concerning the quality control are shown at the end of the test.

To enable/disable the quality control, click on **Enable Quality Control** checkbox.

Parameters manager

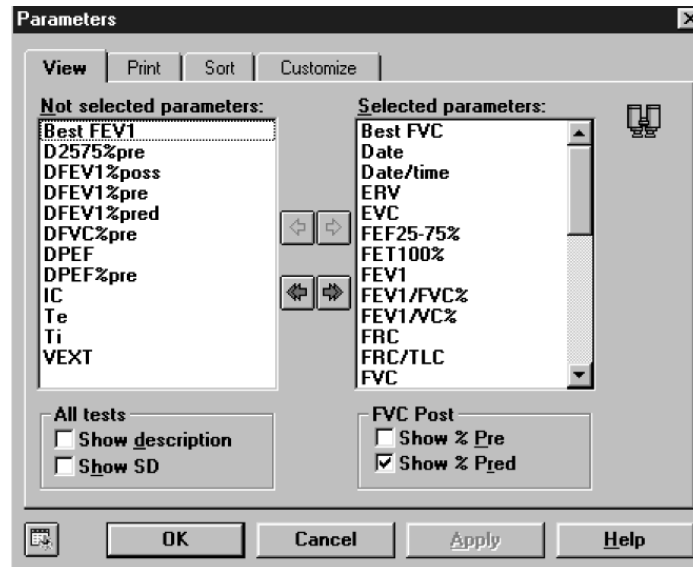

The program allows to calculate a huge number of parameters; it is advisable, in order to simplify the analysis of the results, to view, to print and to sort the desired parameters only. Select the menu item **Options/Parameters...**

View

Move the parameters to view into the *Selected parameters* list.

Print

Move the parameters to print into the *Selected parameters* list.

Sort

Drag the parameter up or down with the mouse.

Customise

Add, modify and delete custom parameters.



If it is necessary to restore the default parameters press the button in the left corner of the window to initialise the parameters database.

Predicted values manager

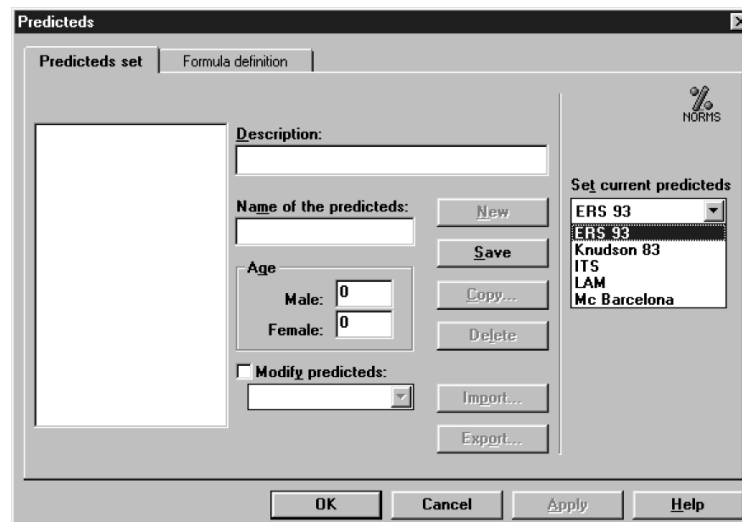

The program contains a preset of predicted equations, but the user is allowed to customise its own predicted sets. Select **Predicteds...** from **Options** menu.

The window is divided into two forms: **Predicteds set** and **Formula definition**.

Predicteds set

This form allows the user to manage the set of predicted. The following information define a set:

Name: identifies the set and cannot be duplicated;
 Description: free field;
 Age: the adult predicted starts since this age.

To enter a new set of predicted values click on the **New** button. The field **Name** must be filled and must be unique. To stop without saving click on the **Cancel** button. To save the set, click on the **Save** button.

To delete a set of predicted values click on the **Delete** button. If a set is deleted, also the associated formulae are deleted.

It is possible to generate a new set of predicted values with the same attributes and the same formulae of the selected one. To do this click on the **Copy...** button and specify a new Name.

To import a set of predicted values click on the **Import...** button and select a file of Predicted values files type.

To export a set of predicted values click on the **Export...** button.

In the list **Set current predicted** choose the current predicted values for printing and viewing.

Set the current predicted

Quark b^2 allows to calculate the predicted values according to the following configurable sets:

Adult	Paediatric
ERS 93	Zapletal
Knudson83	Knudson83
ITS white	ITS white
ITS black	ITS black
LAM	LAM
MC Barcellona	MC Barcellona
Nhanes III	Nhanes III

Select the desired choice in the group **Predicted**.

Formula definition

This form allows the user to manage the formulae associated to a set of predicted values.

Select the set of predicted values from the list **Predicted** set.

To insert a new parameter click on the **New...** button.

The parameter formulae can be:

- calculated according to the predicted values in the list **Use the predicted values formulae**;
- customised by the user with the option **...or the customised formulae**.

The **Delete** button deletes the selected parameter.

The **Copy** button stores the selected parameter in memory.

The **Paste** button inserts a new parameter from the one copied. If the name is not unique, the user is asked whether to specify a new name or to replace the existing parameter.

Page set-up

Select **Page Setup...** from the **File** menu.

Header	All the printouts carried out by the program are preceded by 3 rows of customisable header (usually they contain the name and the address of the Hospital using the spirometer).
Data	Patient and visit information are printed below the header. These data are reported on 3 columns and 5 rows. the user may configure the disposition, change and eventually cancel the fields, as he prefers.
Margins	Configures the print margins from the borders of the paper. The unit of measure is decided in Units of measurements .
Footer	Configures information at the bottom of the page.
Printed file name	Defines the automatic name to be assigned to the pdf file, if the report will be printed in this format.

In the example it has been set to create a filename composed by <date of the test> followed by <last name> and <first name>.

Spirometry tests



Note: Read carefully the contraindications in Chapter 1.

Once completed the phases of the introduction of the patient's data and the visit data, it is possible to carry out the spirometric tests.

Quark b² allows to perform the following tests:

Key	Test
FVC pre	Forced Vital Capacity
FVC post	Forced Vital Capacity after bronchial stimulation
SVC	Slow Vital Capacity
MVV	Maximum Voluntary Ventilation

Before performing any test make sure that:

1. Quark b² is properly connected to your PC and the selected serial port (COM1, COM2) corresponds to the one effectively use.
2. The name shown on the status bar corresponds to the patient who is to carrying out the tests.
3. The today's visit card exists.

Forced Vital Capacity (pre)

FVC is a reference test to verify obstructive (airflow limitations) and restrictive disorders (lung volume limitations). To achieve good test results it is fundamental a good manoeuvre (quality control messages, real time plots ...)

The main parameters measured during FVC tests are:

FVC	Forced Vital Capacity
FEV1	Forced Expiratory Volume in 1 second
FEV1/FVC%	FEV1 as a percentage of FVC
PEF	Peak Expiratory Flow
FEF25-75%	Forced mid-Expiratory Flow

The two representative plots are the Flow/Volume and Volume/Time loops.

By comparing FVC, FEV1 and FEV1/FVC% values the software allows an automatic interpretation concerning the levels of obstructive and/or restrictive disorders.

Recommendations

- The flowmeter has to be disconnected from the breathing valve
- The patient should wear the nose clips
- The turbine has been recently calibrated (ATS recommends a daily calibration)
- The paper mouthpiece or the antibacterial filter is properly connected to the flowmeter through the corresponding adapter

For hygienic reasons, we strongly recommend the use of a bacterial filter.

If a kid must perform the test it is recommended to enable the encouragement function which shows exactly the manoeuvre of the FVC test.

Perform a FVC (pre) test



1. Select **Forced Vital Capacity pre** from the **Test** menu and wait for the green led is prompted on the right side of the screen.
2. Explain the manoeuvre to the patient and press the **F2** key.
3. Wait some seconds and perform the test.
4. After having performed the test, press **F3** or wait for the automatic end (5 seconds without flow), so that the software displays the F/V and V/t graphs, the main parameters, and the predicted values.
5. In order to visualise the F/V and V/t graph and the main parameters press the following buttons:



view Flow Volume graph



view Volume Time graph



view data of the test



6. Press **Alt+F3** to stop the acquisition discarding the results.
7. Repeat the test until it is correctly performed (ATS recommends 3 times).
8. Press **Exit** to visualise the test list carried out during current session together with the results of the main parameters.
9. Select the test that you want to save (the Best Test according to the ATS criteria is highlighted as default) and press **OK**.



Test encouragement

During FVC manoeuvre you might experience some lack of collaboration with kids or with other patients. In this case you may find a good help in using the encouragement software tool.

Perform the FVC test with the encouragement

1. Select **Encouragement** from **View** menu.
2. Perform the test as explained in the previous paragraph.

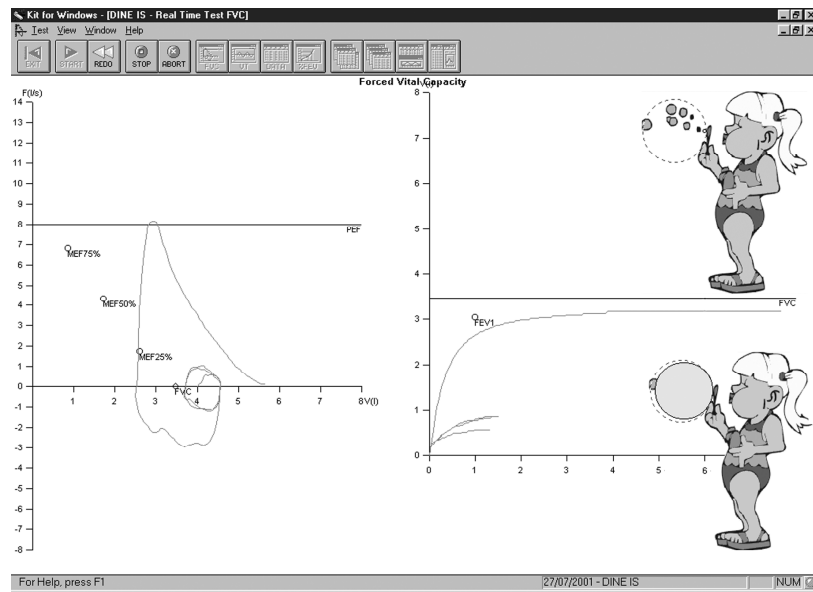

Slow Vital Capacity

Important test for assessing COPD (chronic obstructive pulmonary disease) patients affected by this disease might present a the Slow Vital Capacity could be higher than the Forced one (FVC).

The main parameters measured during SVC tests are:

EVC	Expiratory Slow Vital Capacity
IVC	Inspiratory Slow Vital Capacity
ERV	Expiratory Reserve Volume
IRV	Inspiratory Reserve Volume

If the inspiratory/expiratory maximal manoeuvre is preceded by a some breaths at tidal volume the software allows to measure the Respiratory Pattern, represented by the following parameters:

VE	Ventilation per minute
Vt	Tidal volume
Rf	Respiratory frequency
Ttot	Breath time
Ti/Ttot	Inspiratory time/Ttot
Vt/Ti	Vt/Ti

Perform a SVC test



1. Select **Slow Vital Capacity** from the **Test** menu and wait for the green led is prompted on the right side of the screen.
2. Press **F2** and instruct the Patient to breath normally until the message “carry out...” is prompted; then ask to perform a Slow Vital Capacity (deep inhalation, maximal slow expiration and deep inhalation again).
3. Press **F3** or wait for automatic interruption (5 seconds without flow) in order to visualise the V/t graph together with the main parameters compared to the predicted values
4. To visualise the V/t graph and the main parameters press the follow buttons:



view Volume Time graph



view data of the test



5. Press **Alt+F3** to stop the acquisition discarding the results.
6. Repeat the test until it is correctly performed (ATS recommends 3 times).
7. Press **Exit** to visualise the test list carried out during current session together with the results of the main parameters.
8. Select the test that you want to save (the Best Test according to the ATS criteria is highlighted by default) and press **OK**.

The reference for the ERV calculation is displayed on the V/T graph.

Maximum Voluntary Ventilation

Test for assessing the maximum ventilatory capacity. In the past, it was commonly performed during routine PF tests, however its clinical use declined over the years. Today MVV test is most commonly performed as part of the exercise tolerance tests, where it is used as an index of maximum ventilatory capacity. Test consists in breathing in and out deeply and rapidly for 12, 15 seconds. The expired volume during this short period is then extrapolated

The most important measured parameter is the following:

MVV Maximum Voluntary Ventilation

Perform a MVV test



1. Select **Maximum Voluntary Ventilation** from the **test** menu and wait for the green led is prompted on the right side of the screen.
2. Press **F2** and make the Patient breath as much deeply and rapidly as possible for at least 12 seconds.
3. Press **F3** or wait for automatic interruption (5 seconds without flow) in order to visualise the V/t graph together with the main parameters compared to the predicted values
4. To visualise the V/t graph and the main parameters press the follow buttons:



view Volume Time graph



view data of the test



5. Press **Alt+F3** to stop the acquisition discarding the results.
6. Repeat the test until it is correctly performed (ATS recommends 3 times).
7. Press **Exit** to visualise the test list carried out during current session together with the results of the main parameters.
8. Select the test that you want to save (the Best Test according to the ATS criteria is highlighted as default) and press **OK**.

Bronchial Provocation Test

Bronchodilator test



Note: Read carefully the contraindications in Chapter 1.

Bronchodilators are administered routinely in the b² laboratory to determine whether airflow obstruction is reversible. Bronchodilators increase airway calibre by relaxing airway smooth muscle.

The test consists of comparing results between the reference FVC (FVC PRE) and the FVC POST performed after the administration of the drug. Increasing value of 13-15% of FEV₁, respect to the basal value (FVC Pre) is considered as a reversible condition.

Main parameters are the following:

D_{FEV1}%pre Change of FEV₁ as a percentage of test PRE

D_{FVC}%pre Change of FVC as a percentage of test PRE

D_{PEF}%pre Change of PEF as a percentage of test PRE

Some authors states that the above mentioned parameters are too dependent from the FVC Pre, hence latest reference (ERS93, [A comparison of six different ways of expressing the bronchodilating response in asthma and COPD; reproducibility and dependence of pre bronchodilator FEV₁: E. Dompeling, C.P. van Schayck et Al; ERJ 1992, 5, 975-981]) recommend the following parameters:

D_{FEV1}%pred Change of FVC as a percentage of predicted value

D_{FEV1}%poss Change of FEV₁ as a percentage of “possible value”

Methacholine and Histamine Bronchial provocation Tests

The most common indication for performing methacholine and histamine bronchial challenges is to diagnose hyperresponsive airways. Some patients demonstrate normal baseline pulmonary function despite complaints of “tightness” wheezing, cough, and a little or not response to bronchoconstrictor. Other patients demonstrate spirometric improvement after use of bronchoconstrictor have diurnal variation in peak flows. In this groups aerosolised bronchial challenges are used to confirm a diagnosis of Asthma.

We can summarise the use of the test as follows:

1. Diagnose asthma
2. Confirm a diagnosis of asthma
3. Document the severity of hyperresponsivness
4. Follow changes in hyperresponsivness

When patients with hyperresponsive airways inhale certain pharmacologic agents (i.e. Methacholine or histamine) the airways respond by constricting.

Test consists of executing repeated FVC following the pharmacologic agents inhalation according to an established protocol. The fall of the FEV₁ parameter is used to calculate the bronchial hyperresponsivness. The most important parameter is the PD₂₀ that is amount of drug (mg/ml) that causes a reduction of 20% of the FEV₁ respect the basal value (without drug).

Main parameters are:

P₁₀ Dose that causes a 10% fall of FEV₁.

P₁₅ Dose that causes a 15% fall of FEV₁.

P₂₀ Dose that causes a 20% fall of FEV₁.

The representative plot is the *Dose/response curve*, showing the percentage variation of FEV₁ versus the Drug dose in logarithmic scale.

The program assumes as the **baseline test** the best **FVC pre** carried out during the today’s visit. You can change the reference pre test editing the **Post** test.

The name of the drug, its quantity and its unit of measurement, can be typed immediately before any **FVC post** manoeuvre (manual protocol) or can be stored in a database of bronchoprovocation (**File/Bronchial Provocation protocols Database...**).

Perform the test



(During 1st step only) select **Protocol...** from the **Test** menu and choose the name of the bronchoprovocation protocol that you are going to use (**manual protocol** if you want to type the information about the agent before any manoeuvre)

1. Select **FVC post** from the **Test** menu.
2. Select an existing protocol or click on “manual protocol”, and wait the green leds turned on.
3. Press **F2**, or the button by side, to start the test.
4. Press **F3**, or the button by side, to achieve the test.
5. In order to visualise the V/t graph and the main parameters press the follow buttons:



view Flow Volume graph



view data of the test



view bronchial provocation response

6. Press **Alt+F3** to stop the acquisition discarding the results.
7. Repeat the test until it is correctly performed (ATS recommends 3 times).
8. Press **Exit** to visualise the test list carried out during current session together with the results of the main parameters.
9. Select the test that you want to save (the Best Test according to the ATS criteria is highlighted as default) and press **OK**.

Bronchial Provocation protocols Database

The response to a bronchoprovocator is usually assessed in terms of change in the FEV1, vital capacity or airways resistance on the basis of serial measurements (FVC manoeuvres) in which the results of the initial test constitute the reference values. The international literature proposes several standardised protocols in order to address the methodological issues of the various available techniques.

The possibility to store a bronchoprovocation protocol in a database is useful to simplify and automate the sequence of operations that the Physician need to execute during the bronchoprovocation tests.

The typical sequence of activities to carry out a bronchoprovocation test are:

1. Typing and storing a bronchoprovocation protocol in the database (usually only once).
2. Selection of protocol among the list of the ones already present in the database before carrying out the FVC post tests (the selection of “manual protocol” allows to execute the test fully manually).
3. Performing the Post tests.

Enter a new Bronchial provocation protocol in the archive

1. Select **Bronchoprov. protocols database** from the **File** menu.
2. Type the Protocol name, the Bronchoprovocator name and the unit of measurement in the proper input fields.
3. If the bronchoprovocator has a cumulative effect select the cumulative check button.
4. Enter the quantities for each step and press the button .

Viewing results

All the visualisation functions refer to the test carried out by the Current Patient, whose name is indicated on the left-side of the status bar.



To view tests results:

1. Select the **Patients** from the **File** menu
2. Select the patient corresponding to the test you want to view.
3. Select in the list box of the tests up to 5 tests of the kind (FVC, VC/IVC, or MVV) and press **OK**.

To switch between graph and or data use the following buttons on the toolbar:



view Flow Volume graph (F5)



view Volume Time graph (F6)



view data of the test (F7)



view bronchial provocation response.

If you need more than one visualisation meantime use the **New Window** function from the **Window** menu.

If you need to display a list of visits:

- Select **Visits list...** from the **File** menu.
- Type the name of the Company and/or the time interval desired or simply confirm for the complete list.

Tests of the current patient

If a **current patient** has been selected you can quickly view his tests selecting **Test current patient...** from the **View** menu.



Delete a test

1. Select **Patients** from the **File** menu or press the button by side.
2. Select the test that you want to eliminate from the list of the tests referred to the Current Patient and press **Delete**.

Printing results

You can print out in three different ways:

- printing the Report
- printing the Active Window
- printing a series of reports

Printing Reports



To print a report of the current visit, select **Print report...** from **File** menu. The software will choose automatically the best performed test.

The standard Report is composed by 1, 2 or 3 pages depending if you wish to printout the FVC data and the graphs together on the first page or if you wish to printout the bronchoprovocation response.

- Selecting the option **One page (no ATS)** the report will contain, on one page, the F/V and V/t graphs of the best test, overlapped on the **FVC Post**, the patient data, the notes, the diagnosis and the test results.
- Otherwise the report will contain two pages, the first with the patient data, the graphs and the diagnosis, and the second one with the measured parameters, according to the ATS recommendations.
- The 3rd page will contain the bronchoprovocation response.

Select the desired options:

FVC graph	Prints the F/V and V/t curves for the best FVC test.
One page (no ATS)	Prints data and graphs on the first page.
Response	Prints the bronchoprovocator response.
Preview	Views a report preview on the screen.

Printing the active window



This printout function is only enabled when the active window (title bar highlighted) is one of the following objects:

- Any kind of Graph.
- Numeric data
- List of visit

To print the active window

1. Ensure that the active window is one of the preceding objects.
2. Select **Print Active window** from **File** menu.

Printing a series of reports

Sometimes it is useful to printout automatically a series of reports (all tests carried out with the employees, all tests carried out in the today's session).

To print out proceed as follows:

1. Select **Visit List** from the **File** menu
2. Set the criteria of the visits to be added in the list (from, to,...)
3. Select **Print Report** from the **File** menu.

Electronic reports (*.pdf)

If an Adobe PDF writer "Printer Driver" is installed and set as the default printer, it is possible to store the printout report automatically in any location of the HD or eventually LAN paths according to a customizable filename format.

It is possible to define the created filename format selecting **File/Page Set up...** (see Page set-up).

Export data

With this function you can export the test data in 4 different formats:

- *.txt (ASCII)
- *.xls (Microsoft Excel)
- *.wk1 (Lotus 123)
- *.xpo (Cosmed)

Export a test

1. Select **Export tests** from the **File** menu.
2. Select the test to export from the list box and press **OK**.
3. Type the name and the format of the file in the dialog **Save as**. If the ASCII format is selected, the Text button in the dialog box Save as allows you to configure the separators for character based files.

With the *.xpo Cosmed file format it is possible to import data from another Quark archive. Press **OK** to confirm.

4. Select the folder for the export and type the file name. Press **OK** to confirm. A status bar will show the file creation.



System maintenance

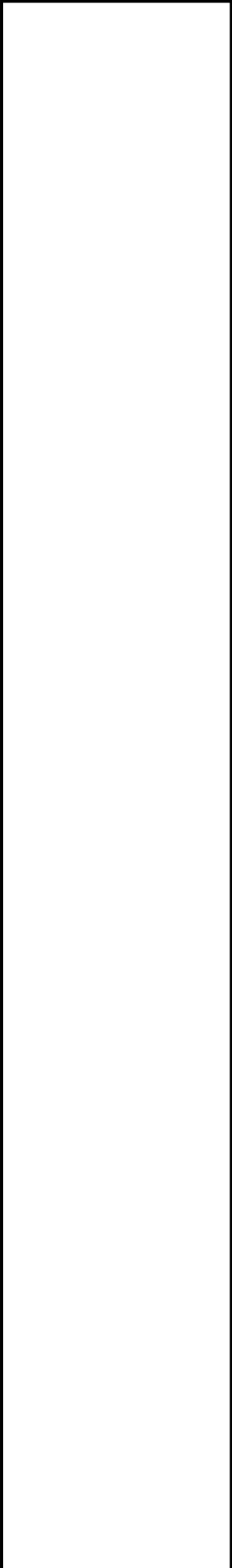

System maintenance

All service operations which are not specified in this user manual should be performed by qualified personnel in accordance with the service handbook (to be required to the manufacturer).

Rubber mouthpieces, face masks, breathing valve and the other parts are not shipped sterile. They should be disinfected before using according to the following instructions.

All materials used in the construction of the Quark b² are non toxic and pose no safety risk to the patient or operator.

Prior to the device cleaning, disinfection and inspection it is necessary to switch off the device and to disconnect adapters from the supply mains.

In order to guarantee the highest accuracy of measurements we recommend you to disinfect the turbine periodically.

Use disposable anti-bacterial filters or disinfect each part in contact with the patient before each test.

Cleaning and disinfection

Cleaning and disinfecting instructions are of fundamental importance to control infections and assure patient safety. In fact aspiration of residue, particles and contaminated agents are life – threatening.

In this handbook we strongly recommend you to follow the rules worked out by ATS and ERS (see: "Lung Volume Equipment and Infection Control" – ERS/ATS WORKSHOP REPORT SERIES, European Respiratory Journal 1997; 10: 1928 – 1932), which are summarised as follows:

- Accessible internal as well as external surfaces of equipment exposed to expired gas should be washed and disinfected prior to testing of subsequent patients.
- Liquid disinfection can be used if the equipment is well cleaned first (no droplets of saliva/sputum remain).
- Disposable gloves should be worn when handling mouthpieces, when cleaning equipment exposed to saliva or sputum and especially when drawing blood.
- Laboratory staff should wash hands prior to testing of each patient.
- Adopt particular precautions when testing patients with recognised high – risk communicable diseases (e.g. tuberculosis, multidrug – resistant staphylococcus). In these cases, the clinical need for such testing should justify the risks.

During the disinfection:

- do not use alcohol or other liquids containing gluteraldehyde on the exterior surfaces of the equipment. Actually they can damage polycarbonates plastics and may produce unhealthy substances.
- do not use abrasive powders or glass cleaners containing alcohol or ammonia on the plexiglas components of the equipment
- do not steam autoclave any parts of the equipment unless it is clearly specified.
- do not immerse the optoelectronic reader.

Preparing the disinfecting solution

The following recommendations are retrieved from:

APIC (Association for Professionals in Infection Control and Epidemiology, Inc.): APIC Guidelines for Selection and Use of Disinfectants; William A. Rutala, PhD, MPH, CIC. American Journal of Infection Control, vol.24, N.4, pp. 313-342, August 1996 - <http://www.apic.org/pdf/qddisinf.pdf>

As disinfecting solution it is suggested:

- Sodium hypochlorite 0.5% (5000 ppm) prepared fresh for use within 24 hours.
- Sodium hypochlorite 1% (10000 ppm) prepared fresh for use within 30 days.

The first solution can be easily prepared by adding 1 part household bleach (sodium hypochlorite 5.25%) to 9 parts water, the second one by adding 1 part household bleach to 4 parts water.

Cleaning the turbine flowmeter



Warning: Do not use alcoholic solutions for the turbine, otherwise there can be damages to the plastic material.

It is necessary to disinfect periodically the turbine for sanitary measures or/and for the correct device function.

The disinfecting procedure is easy and may be effected every time the user needs, keeping attention to some precautions:

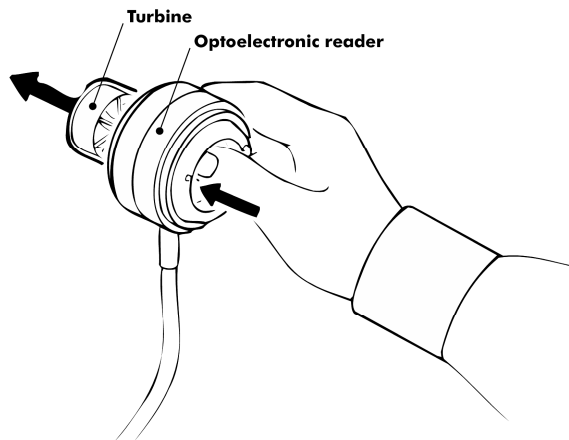

1. Take out the turbine.
2. Dip it in a disinfectant solution (non alcoholic based) for about 20 minutes.
3. Rinse the turbine in a vessel, filled of clean water, shaking gently to remove the disinfectant (do not clean the turbine by putting it under running water!).
4. Let it dry to air.
5. After cleaning the turbine, check if the turbine propeller rotates freely even with a low speed air flow.
6. Connect the turbine to the reader.

Precautions during the cleaning of the turbine

1. Do not expose the turbine to high heat and do not put it under running water.
2. Do not ever dip the optoelectronic reader in any kind of solution, the liquid infiltration would damage the internal circuit.
3. Do not use alcoholic solutions to clean the turbine.

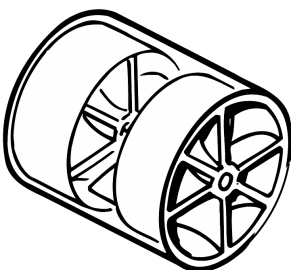

Masks cleaning and disinfection

The face masks should be cleaned and sterilised after each test.

Disassembling the different parts of the mask

1. Remove the valves from their place.
2. Remove the adapter for the optoelectronic reader.

Cleaning the mask

1. Clean the mask with hot water and a soap solution to remove the impurities.
2. Rinse the mask with energy in running hot water.

Warning: Do not use synthetic or petroleum-based products for the masks cleaning.

Disinfecting the mask

It's possible disinfecting the mask following these procedures:

- Standard autoclaving method
 - Rapid cycles of autoclave lasting 10 minutes at 132°C (270°F)
 - Heavy cycles of autoclave lasting 30 minutes at 121°C (250°F)
 - Pre vacuum cycles of autoclave lasting 30 minutes at 121°C (250°F)
- Ethylene oxide method (ETO)

The ethylene oxide doesn't deteriorate the face masks. Sterilisation by this method is not advised unless sufficient data is available regarding the time required for complete out-gassing of residual ETO. If you use this method, follow carefully the instruction provided by the maker of the sterilising product.

- Pasteurisation

The disinfecting with hot water is a sterilising method that may be used with the silicone masks.

Canopy bubblehood (option) cleaning

The Canopy bubblehood must be cleaned after each usage with a soft cloth and a non aggressive as well as not alcoholic detergent.

RMR reader (option) cleaning

The disinfecting procedure is easy and may be performed any time the user needs to do it by keeping attention to some precautions:

1. Disconnect the sampling tube from the reader
2. Plunge the reader only in a vessel containing disinfectant solution for 20 minutes circa, as per the picture below, paying attention of not wetting the sampling tube.



3. Rinse the turbine in a vessel, filled of clean water, shaking gently to remove the disinfectant (do not clean the turbine by putting it under running water!).
4. Let it dry to air.
5. After cleaning the turbine, check if the turbine propeller rotates freely even with a low speed air flow.

Precautions during the cleaning of the turbine

- Do not expose the turbine to high heat and do not put it under direct water-spout.
- Do not wet neither the sampling tube nor the connector on the other end of the cable
- Do not use alcoholic solutions to clean the turbine.

Two-way non rebreathing valve cleaning (option)

Refer to the indications reported in the sheet shipped together with the valve.

The valve must be disinfected after each usage on a patient.

Mixing chamber cleaning and disinfection (option)

Before disinfecting the mixing chamber, disassemble it unscrewing the screws in the top cover.

Note: do not use alcohol, solvents or other abrasive substances for cleaning the mixing chamber.

For disinfecting the mixing chamber, plunge each part in the disinfecting solution for 20 minutes. Rinse and wipe.

After the cleaning, carefully close the mixing chamber.

Permapure maintenance

- Do not bend, squash or deform it.
- Do not keep it in open air, if not used, especially in crowded or smoky places.

-
- If saliva is entered in the tube, replace it immediately, because it lost its functions.
 - Periodically grease the o-ring on the connector in order to simplify the flowmeter connection.
 - Replace it every 100 test / 6 month.

Inspections

The equipment requires easy inspections to be carried out in order to assure a proper electrical and mechanical safety level in the years.

These inspections are highly recommended after a rough use of the equipment or after a period of storage in unfavourable environmental conditions.

Referring to the electrical safety, it is important to check the conditions of insulation materials of cables, plugs and any other visible part by means of simple inspection, when the equipment is switched off and adapters (or electrical feeders) are disconnected from the supply mains.

Mechanical parts to check are: the turbine and breathing circuits.

Follow these instructions:

- extract the turbine from the optoelectronic reader;
- verify, by inspection, that the turbine axis fits correctly its seats and the blade is strongly fastened on the axis itself (it can be useful to shake slightly the turbine in order to note any anomalous movement).

Check if there are any torn or broken components in the breathing circuits: remember that they can create safety risk to patients during tests.

Replace the fuses

The fuses can be replaced easily in the following way:

1. Open the power supply cover using a screwdriver as shown in the picture.

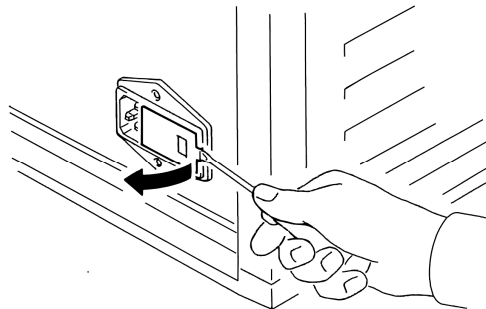

2. Extract the fuse holder as shown in the picture

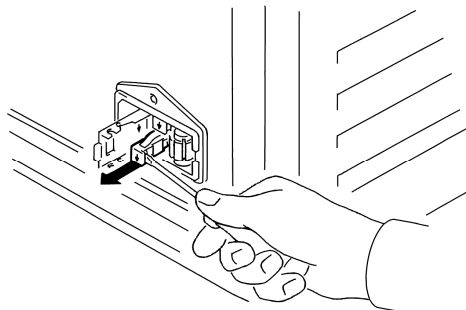

3. Replace the damaged fuse(s).

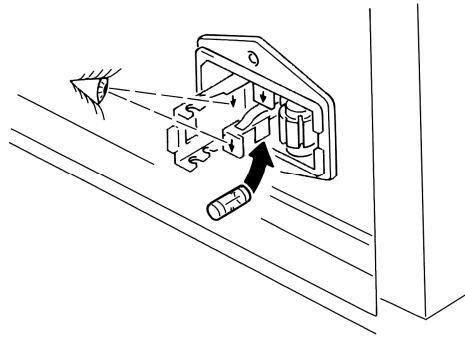

Note: Be careful to use proper fuses:
A 680 013 630 (Time Lag Fuses 5x20 250V T 630 mA) for 220/240V supply
A 680 024 125 (Time Lag Fuses 5x20 250V T 1,25A) for 100/120V supply

Select the proper power supply voltage

The power supply voltage can be changed in the following way:

1. Open the power supply cover using a screwdriver.
2. Rotate the voltage selector in order to read the desired value.

Appendix

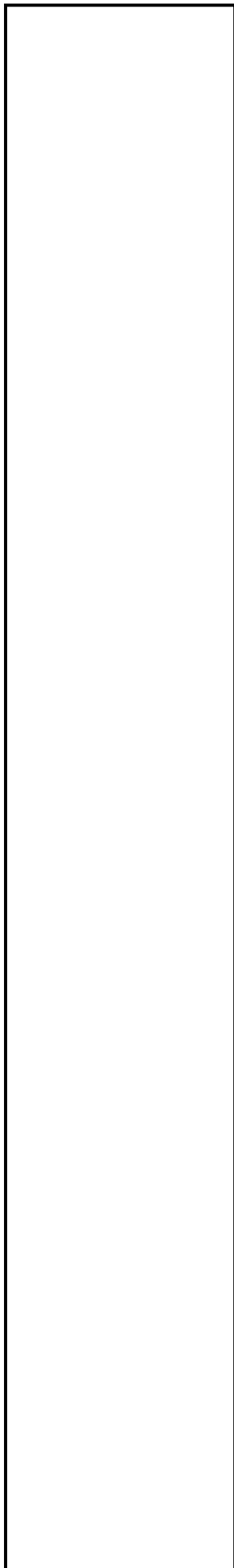

Conformity declaration

Manufacturer: COSMED S.r.l.
Address: Via dei Piani di Monte Savello 37,
00040 Pavona di Albano Laziale (RM)
ITALY
phone: +39-06-9315492
fax: +39-06-9314580

manufacturer of the following equipment:

Quark b²

declares under his sole responsibility that:

- the above listed equipment comply with the essential requirements of the Annex I of the Medical Device Directive 93/42/EEC;
- are classified in Class IIa;
- their design, manufacturing and final checks are performed according the Cosmed's Quality System, conform to ISO 9001:2000 and ISO13485:2003 Norms, certified by CERMET (certificates nr. 387-A and 387-M);
- are CE marked according to the Medical Device Directive 93/42/EEC and certified by CERMET (certificate nr. MED 9811).

The equipment conform with the following specifications:

Safety: CEI 62-5/IEC 60601-1/EN 60601-1

EMC: EN 60601-1-2

Warranty and limitation of liability

COSMED provides a one (1) year limited warranty from the date of the original sale of COSMED products. All COSMED products are guaranteed to be free from defect upon shipment. COSMED's liability for products covered by this warranty is limited exclusively to replacement, repair, or issuance of a credit for the cost of a defective product, at the sole discretion of COSMED. COSMED shall not be liable under the foregoing warranty unless (i) COSMED is promptly notified in writing by Buyer upon discovery of defect; (ii) the defective product is returned to COSMED, transportation charges prepaid by Buyer, (iii) the defective product is received by COSMED no later than four weeks after the last day of the one (1) year limited warranty period; and (iv) COSMED's examination of the defective product establishes, to COSMED's exclusive satisfaction, that such defect was not caused by misuse, neglect, improper installation, unauthorised repair or alteration, or accident. If the product is manufactured by a third-party, COSMED shall make available for the Buyer's benefit only those warranties which COSMED has received from the third-party manufacturer(s). COSMED hereby specifically disclaims any and all warranties and/or liabilities arising from defect(s) and/or damage(s) to and/or caused by products manufactured by third-party manufacturers. Buyer must obtain written authorisation from COSMED prior to the repair or alteration of COSMED product(s). Failure of Buyer to obtain such written authorisation shall void this warranty.

COSMED hereby specifically disclaims any and all other warranties of any kind, whether express or implied, in fact or by law, including, but without limitation, any and all warranties of merchantability and/or fitness for a particular purpose.

COSMED shall not be liable for special, indirect and/or consequential damages, nor for damages of any kind arising from the use of any COSMED's products, whether said products are used alone or in combination with other products or substances.

Determination of the suitability of any of COSMED's product(s) furnished hereunder for the use contemplated by Buyer is the sole risk and responsibility of Buyer, and COSMED has no responsibility in connection therewith. Buyer assumes all risks and liabilities for loss, damage or injury to persons or property of Buyer or others arising out of the use or possession of COSMED's products.

The limited warranty as herein above set forth shall not be enlarged, diminished, modified or affected by, and no obligation or liability shall arise or grow out of, the renderings of technical advice or service by COSMED, its agents or employees in connection with Buyer's order or use of the product(s) furnished hereunder.

Return goods policy for warranty or non warranty repair

Goods shipped to COSMED for repair are subject to the following conditions:

1. Goods may only be returned after your receipt of a **Service Return Number (SRN)** from COSMED S.r.l.
2. Place your SRN report and Packing List outside the package.
3. Goods returned must be shipped with freight and insurance charges prepaid. **Collect shipments will not be accepted.**
4. The following list of goods are not eligible for return unless proven defective.
 - Special order items
 - Expendable products
 - Goods held over 30 days from COSMED's invoice date.
 - Used goods not in original shipping containers.
 - Goods which have been altered or abused in any way.
5. The following parts are not covered by warranty:
 - consumables
 - fragile glass or plastic parts
 - rechargeable batteries
 - damages at the
 - damages due to use of the device not conforming to the indication reported in this manual

Repair Service Policy

Goods returned to seller for Non-Warranty repair will be subject to conditions 1, 2, 3, 4. The returned goods need to re-enter COSMED together with the customs documents (Pro-forma Invoice and Customs Paper) as requested by the Italian law.

- The shipment has to be qualified as a Temporary Export.
- All the goods returned to COSMED without the customs papers will not be accepted.

For European Community members:

Pro-Forma invoice complete with:

- Number
- Description of the goods
- Quantity
- Serial Number
- Value in €
- Number of parcel
- Gross weight
- Net weight
- Reason for resent (i.e. Resent for repair)

In case you should send the system for repair please contact the nearest service centre or contact COSMED at the following address:

COSMED S.r.l.

Via dei Piani di Monte Savello 37
P.O. Box 3
00040 Pavona di Albano - Rome, Italy
tel. +39 (06) 9315492
fax +39 (06) 9314580
E-mail: customersupport@cosmed.it

For USA customers only please contact:

COSMED USA Inc

2211 North Elston, Suite 305
Chicago IL 60614 USA
Phone: +1 (773) 645-8113
Fax: +1 (773) 645-8116
email: usa.sales@cosmed.it

To ensure that you receive efficient technical assistance, please specify as precisely as possible the nature of the problem as it is specified on the assistance information form.

We advise you to save the original packaging. You may need it in case to ship the unit to a technical assistance centre.

Privacy Information

Dear Customer,

we inform you that your personal data are gathered and will be used by Cosmed Srl in conformity with the requirements of the Italian privacy law (Decreto Legislativo 196/2003). We believe it is important for you to know how we treat your personal data.

Personal data treatment and purposes

We request and process your personal data:

- a. to place an order, register a product, request a service, answer a survey, enter a contest, correspond with us (all of the above, in the following: “service”) and, if necessary, to supply the Competent Authorities with the required information;
- b. in order to define your commercial profile;
- c. in order to use your commercial profile for own marketing and advertising purposes;
- d. for accounting purposes, including e-mailing of commercial invoices;
- e. for providing your information to selected business partners (also abroad), in order to supply the service;

How your personal data are treated

Your personal data will be stored in electronic format, and protected at the best from destruction, loss (even accidental), not authorized accesses, not allowed treatment or use not in conformity with the purposes above listed.

The consent is optional, but...

If you deny the consent, we regret we cannot supply the service.

Holder of the treatment

The holder of the treatment is Cosmed Srl, Via dei Piani di Monte Savello 37, Pavona di Albano Laziale (RM). The responsible of the personal data treatment is indicated in the documentation stored by Cosmed Srl itself.

Customer rights

In accordance with art.7 of the Law, you can:

- a. obtain confirmation of the existence of your personal data and their communication in intelligible form;
- b. obtain:
 - updating, correction or integration of your data;
 - deletion or transformation in anonymous form of your personal data;
- c. deny your consent to the treatment of your personal data;

These rights can be exercised directly requesting in writing to the holder of the treatment.

Waste of electrical and electronic equipment

Quark b² is an electronic equipment and can not be disposed as unsorted municipal waste. Electric and electronic equipment, according to European Directive 2002/96/EEC, must be collected separately. Otherwise it can cause dangerous consequences for the environment and human health.

The crossed-out wheeled bin means that the product must be taken to separate collection at the product end-of-life.

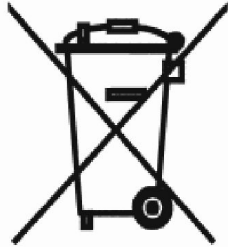

Analog - Digital auxiliary inputs

With the eight analog inputs, the auxiliary RS 232 port and the digital (TTL) input for external ECG signal, Quark b² offers the possibility to integrate data coming from many equipment such as ECGs and ergometers.

AUX RS232

This bi-directional serial interface is used to connect ergometers such cycloergometers and treadmills in order to read and/or control workload data during an exercise test.

Pin-out assignment

pin	Signal
1	Shield
2	RX
3	TX
5	GND
7	RTS (shortcut with pin 8)
8	CTS (shortcut with pin 7)

Handshaking protocol configuration

Quark b² is compatible with any ergometer incorporating a RS232 serial interface. The handshake protocol can be configured, according to the specification supplied by the manufacturer of the ergometer, by using the program Ergoman.exe contained in the installation disk of the exercise program.

Note: to receive the last update file containing all the handshake protocols already implemented contact directly COSMED or an authorised dealer.

AUX1/ AUX4 analog Inputs

The Quark b² has 8 analog inputs for acquiring analog signals coming from external devices (blood pressure, ECG...); the range of the analog inputs is:

0 to 5 Volts for channels AUX1A, AUX2A, AUX3A and AUX4A

0 to 10 Volts for channels AUX1B, AUX2B and AUX3B

You can order the **Aux interface cable** with the P/N C01557-01-12.

Enable the AUX input

When you receive the Quark b² system from COSMED all the signals inputs are disabled as default; before connecting any external device you need to enable the reading of the channel you have decided to use.

To enable the reading of a channel AUX1A proceed as follows (other channels can be enabled in the same way):

1. Switch off the Quark b² system and open the front Panel removing the 4 screws which fix it to the chassis;
2. Remove the AUX BOARD (5th board from left to right) and configure the dip switches S1 and S2 as shown in the following diagram (AUX1A enabled, all the channels disabled);
3. Connect the open terminals of the Auxiliary Input cable to the external device respecting the labels (GND, AUXA 0-5Volts, AUXB 0-10Volts);
4. Connect the Auxiliary Input cable on the corresponding port on the rear panel of the Quark b².

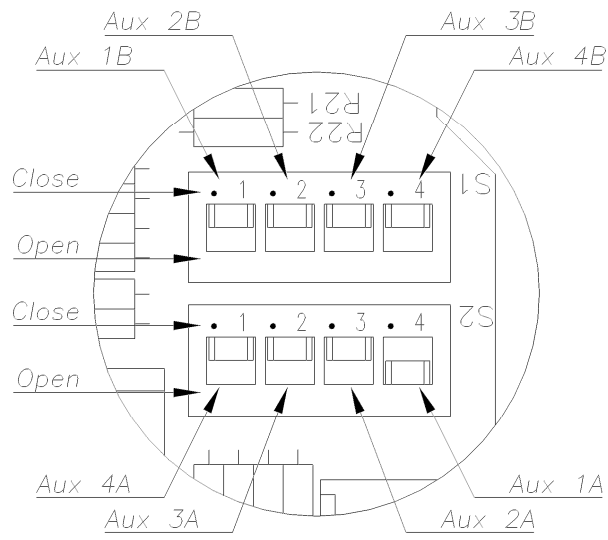

Converting factors configuration



Once completed the connection between the Quark b² and the external system you must configure the options to convert the raw data (mV) into a physical parameter (Blood pressure, skin temperature...).

You can access the configuration window by selecting **Control Panel** from the **Calibration** menu in the calibration program, then pressing the button by side.

You might configure the following options for each of the 8 channels:

Name: identify the parameter

Unit of meas.: unit of measurement

Base line and Gain: factors used to convert the acquired raw data (mV) into the final format according to $Y=(mV-BL)*Gain$. The value entered for gain must be multiplied by 1000 (for Gain=1, enter 1000).

Precision: the number of decimals shown as 0

Pin-out assignment

pin	AUX1 Signal	AUX2 Signal	AUX3 Signal
1	AUX1A (0-5V)	AUX2A (0-5V)	AUX3A (0-5V)
3	AUX1B (0-10V)	AUX2B (0-10V)	AUX3B (0-10V)
4	GND	GND	GND
5	GND	GND	GND

pin	AUX4 Signal
7	AUX4A (0-5V)
nc	AUX4B (0-10V)
4	GND

Heart Rate – TTL input

The Heart Rate TTL input allows to measure the hearth rate signal from any ECG with a pulse signal (0-5 Volts) available or from the POLAR belt receiver probe.

Referring to the connector labelled as HEART RATE on the rear panel of the Quark PFT, the pin out assignment is the following:

pin	Signal
5	TTL input
4	GND

Calculations references

VO₂ and VCO₂

"Energy Expenditure and Fuel Selection in Biological Systems: The Theory and Practice of Calculations Based on Indirect Calorimetry and Tracer Methods": M. Elia, G. Livesey, World Rev. Nutr. Diet. Basel, Karger, 1992, vol 70, pp 68-131.

"Nutritional Assessment in Critical Care, A Training Handbook": Donald C. Zavala

Anaerobic threshold (modified V-Slope)

The break-point or intercept of the two slopes can be selected by a computer program that defines the VO₂ above which VCO₂ increases faster than VO₂, without hyperventilation.

During an incremental exercise above the Lactate Threshold, the net increase in lactic acid production results in an acceleration of the rate of increase in VCO₂ relative to VO₂. When these variables are plotted against each other (squared graph without recovery points), the relationship is composed of two apparently linear components, the lower of which has a slope of slightly less than 1.0, whereas the upper component has a slope steeper than 1.0. The intercept of these two slopes is the LT or AT point measured by gas exchange.

The increase in VCO₂ in excess of that derived from aerobic metabolism must be generated from the buffering of lactic acid. This is an obligatory gas exchange phenomenon seen in all subjects who exercise to work levels above their LT. This technique is referred to as the V-Slope method.

OVS, Original V-Slope method: "A new method for detecting anaerobic threshold by gas exchange", Beaver, Wasserman, Whipp, JAP 1986, 60:2020-2027.

MVS, Modified V-Slope method: "Metabolic acidosis during exercise in patients with chronic obstructive pulmonary disease", Sue, Wasserman, CHEST 1988, 94:931-938.

O₂ kinetics

"Delayed Kinetics of VO₂ in the Transition from prior Exercise. Evidence for O₂ Transport Limitation of VO₂ Kinetics: A Review"; R.L. Hughson and M.A. Morrissey, Int. J. Sports Med. 4 (1983) 31-39

ISO 8996: Ergonomics – Determination of metabolic heat production, 1990

In the following picture it is shown how the O₂ debit and deficit values are computed.

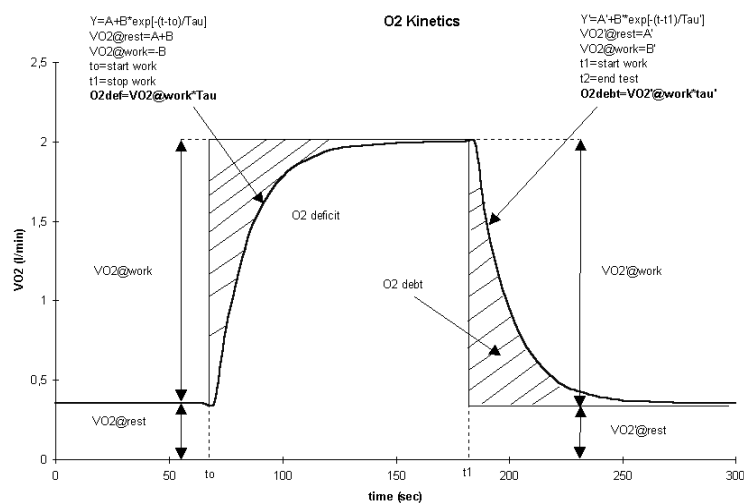

Cardiac Output

Cardiac output estimated non invasively from oxygen uptake during exercise: William stringer, James E. Hansen and K. Wasserman; JAP 82(3): 908-912, 1997

Clinical Exercise Testing - Third Edition - 1988; Norman L. Jones

ATS 94 recommendations

Reference: "Standardization of Spirometry: 1994 Update" "American J. Respiratory Critical Care Medicine", Vol. 152, 1107-1136; 1995.

ATS recommendations

Volume range: 8l (BTPS)
Flow range: ± 14 l/sec
Volume accuracy: $\pm 3\%$ or < 50 ml
Flow accuracy: $\pm 5\%$ or < 200 ml/sec
Flowmeter resistance: < 1.5 cmH₂O da 0 a 14 l/sec

Reproducibility: the 2 largest of 3 acceptable FEV₁ and FVC values should be within 5% or 150 ml.

The end of test: no change in volume for 1 second with at least 6 seconds of collected volume.

Accumulation time: the maximum time allowed for volume accumulation during the VC manoeuvre should be at least 30 seconds and at least 15 seconds during the FVC.

The spirometer should be store at least 8 FVC manoeuvres.

FEV₁ should be calculated by using the "back extrapolation" method to detect the start of the test, extrapolated volume must not be higher then 5% FVC or 150ml.

The graphic resolution of the printed report must be as in the following:

Volume: 10 mm/l
Flow: 5 mm/l/sec
Time: 20 mm/sec
F/V ratio: 2:1

The total number of error (FVC e FEV₁ $> \pm 3.5\%$, FEF_{25-75%} $> 5.5\%$) during the measurement of the 24 standard waveforms must be lower than 4.

Predicted values

ERS93

Standardized Lung Function Testing: Official Statement of the European Respiratory Society, The European Respiratory Journal Volume 6, Supplement 16, March 1993.

Compilation of reference values for lung function measurements in children: Ph. H. Quanjer, J. Stocks, G. Polgar, M. Wise, J. Karlberg, G. Borsboom; ERJ 1989, 2, Supp.4, 184s-261s.

KNUDSON 83

Changes in the Normal Maximal Expiratory Flow-Volume Curve with Growth and Aging: J. Knudson, D. Lebowitz, J. Holdberg, B. Burrows; ARRD 1983; 127:725-734

ITS

Intermountain Thoracic Society: Clinical Pulmonary Function Testing, second edition (1984) pp 101, 144

LAM

A survey of ventilatory capacity in Chinese subjects in Hong Kong: Lam Kwok-Kwong, Pang Shing et Al. Annals of Human Biology, 1982, vol. 9, No. 5, 459-472.

Multicéntrico de Barcelona

Spirometric reference values from a Mediterranean population: J. Roca, J. Sanchis, A. Agusti-Vidal, F. Segarra, D. Navajas. R. Rodriguez-Roisin, P. Casan, S. Sans. Bull. Eur. Physiopathol. Respir. 1986, 22, 217-224.

Nhanes III

Spirometric reference values from a sample of the general US population: John L. Hankinson, John. R. Odencrantz and Kathleen B. Fedan. Am J Respir Critr Care Med 1999, 159, 1798-187.

Pneumobil (Brazil)

Valores extraídos do *Programa Pneumobil/Brasil* para a Tese de Doutorado do Dr. Carlos Alberto de Castro Pereira. (Boehringer).

Gutierrez (Chile)

Gutierrez et Al. Reference values for Chile population

Knudson, Morris and Bass

The maximal Expiratory Flow-Volume curve: Knudson et al. ARRD Vol. 123, p. 659-664, 1981

Spirometric Standard for healthy non-smoking adults: ARRD Vol. 10-3, p. 57-67, 1971

Pereira (Brazil)

Pereira CAC; Barreto SP; Simões JG; Pereira FWL; Gerstler JG; Nakatani J. Valores de Referência para Espirometria em uma amostra da população brasileira adulta. *Jornal de Pneumologia* 1992; 18: 10-22.

Mallozi MC. Valores de referência para espirometria em crianças e adolescentes, calculados a partir de uma amostra da cidade de São Paulo. Valores finais publicados em : Pereira CAC; Lemle A; Algranti E; Jansen JM; Valença LM; Nery LE; Mallozi M; Gerbasi M; Dias RM; Zim W. I Consenso Brasileiro sobre Espirometria. *Jornal de Pneumologia* 1996; 22:105-164.

Scalambrini Costa F, Scueiri CEB, Silva Jr WC, Pereira CAC, Nakatani J. Valores de referência para espirometria em uma amostra da população brasileira adulta da raça negra. *J Pneumologia* 1996;22: 165-170.

Neder JA; Andreoni S; Castelo-Filho A; Nery LE. Reference values for lung function tests. I. Static Volumes. *Brazilian Journal Medical and Biological Research* 1999; 32:703-17.

Neder JA, Andreoni S, Lerario MC, Nery LE. Reference values for lung function tests. II. Maximal respiratory pressures and voluntary ventilation. *Braz J Med Biol Res* 1999 ;32:719-27

Thai

Wanchai Dejsomritrutai; Khun Nanta Maranetra; Kittipong Maneechotesuwan; Nitipatana Chierakul; Jamsk Tscheikuna; Tasneeya Suthamsmai; Arth Nana; Benjamas

Chuaychoo; Phunsup Wongsurakiat; Suchai Charoenratanakul; Wilawan Juengprasert; Chana Naruman: *Reference Spirometric Values for Healthy Lifetime Nonsmokers in Thailand*, J. Med. Assoc. May 2000 (83: 457-466)

DLCO

Standardized Lung Function Testing: Official Statement of the European Respiratory Society, The European Respiratory Journal Volume 6, Supplement 16, March 1993.

Compilation of reference values for lung function measurements in children: Ph. H. Quanjer, J. Stocks, G.Polgar, M. Wise, J. Karlberg, G. Borsboom; ERJ 1989, 2, Supp.4,184s-261s.

Reference Values for Residual Volume, Functional Residual Capacity and Total Lung Capacity - ATS workshop on Lung Volume measurements, official statement of the European Respiratory Society; J. Stocks, Ph. H. Quanjer: ERJ, 1995, 8, 492-506

Single Breath Oxygen Test

Buist SA, Ross BB: Quantitative Analysis of the Alveolar Plateau in the Diagnosis of Early Airway Obstruction. ARRD 108: 1081, 1973

Mansell A, Bryan C, Levison H: Airway Closure in Children. JAP 33: 711-714, 1972

Buist SA, Ross BB: Predicted Values for Closing Volumes Using a Modified Single Breath Test. ARRD 107: 744-751, 1973.

Rint

Lombardi E, Sly PD, Concutelli G, et al. Reference values of interrupter respiratory resistance in healthy preschool white children. Thorax 2001; 56: 691-695.

Mip/Mep

Leo F. Black, Robert E. Hyatt: Maximal Respiratory Pressures: Normal Values and Relationship to Age and Sex, American Review of Respiratory Disease, Volume 99, 1969

Vincken W, Ghezze H & Cosio MG (1987). Maximal static respiratory pressures in adults: normal values and their relationship to determinants of respiratory function. Bull Eur Physiopathol Resp 23: 435-439.

Automatic diagnosis (algorithm)

Reference: "Lung Function Testing: selection of reference values and interpretative strategies", A.R.R.D., 144/ 1991:1202-1218.

LLN=Pred-0.674*SD (ATS, 50° percentile)

LLN=Pred-1.647*SD (ERS, 95° percentile)

LLN=Pred*0.8 (80%Pred)

Message interpretation	Criterion
Normal Spirometry	FVC and FEV1/FVC > LLN
Obstructive abnormality (it may be physiological)	% Pred FEV1 ≥ 100
Obstructive abnormality: mild	% Pred FEV1 < 100 and ≥ 70
Obstructive abnormality: moderate	% Pred FEV1 < 70 and ≥ 60
Obstructive abnormality: moderately severe	% Pred FEV1 < 60 and ≥ 50
Obstructive abnormality: severe	% Pred FEV1 < 50 and ≥ 34
Obstructive abnormality: very severe	% Pred FEV1 < 34
Restrictive abnormality: mild	FVC < LLN and % Pred FVC ≥ 70
Restrictive abnormality: moderate	% Pred FVC < 70 and ≥ 60
Restrictive abnormality: moderately severe	% Pred FVC < 60 and ≥ 50
Restrictive abnormality: severe	% Pred FVC < 50 and ≥ 34
Restrictive abnormality: very severe	% Pred FVC < 34

Quality Control Messages

Reference: Spirometry in the Lung Health Study: Methods and Quality Control, ARRD 1991; 143:1215-1223.

Message	Criterion
Start faster	VEXT >5% of the FVC and >150ml
Blast out harder	PEFT >120 msec
Avoid coughing	50% drop in the flow in first second
Blow out longer	FET100% <6 sec.
Blow out more air	flow >0.2l/s within 20 ml of FVC
Blow out harder	dPEF<10%
Take a deeper breath	dFVC<200ml and 5% best FVC
Blow out faster	dFEV1<200ml and 5% FEV1
That was a good test	No errors
FVC reproducible	diff. 2 max FVC within 0.2 l
FEV1 reproducible	diff. 2 max FEV1 within 0.2 l
PEF reproducible	diff. 2 max PEF within 10 %
MVV time too short	MVV time less than 12 sec

References

Gas Exchange References

["On line computer analysis and breath by breath graphical display of exercise function tests."; Beaver, Wasserman, Whipp, JAP , 34(1):128-132, 1973]

["Measurement and analysis of gas exchange during exercise using a programmable calculator"; Sue, Hansen, Blais, Wasserman, JAP, 49(3), 1980:456-461]

["Principles of exercise testing and interpretation, 2^o edition"; Wasserman et Al, 1994]

["Clinical Exercise Testing, 3rd edition", Jones 1988]

ERS task force on standardization of clinical exercise testing. "Clinical exercise testing with reference to lung disease: indications, standardization and interpretation strategies." J. Roca, B. Whipp, S. Anderson, R. Casaburi, J.E. Cotes, P. Palange...., ERJ 1997; 10: 2662-2689.

Indirect calorimetry

["Energy Expenditure and Fuel Selection in Biological Systems: The Theory and Practice of Calculations Based on Indirect Calorimetry and Tracer Methods": M. Elia, G. Livesey, World Rev. Nutr. Diet. Basel, Karger, 1992, vol 70, pp 68-131.]

["Nutritional Assessment in Critical Care, A Training Handbook": Donald C. Zavala]

Cardiac Output

Cardiac output estimated non invasively from oxygen uptake during exercise: William stringer, James E. Hansen and K. Wasserman; JAP 82(3): 908-912, 1997

Clinical Exercise Testing - Third Edition - 1988; Norman L. Jones

Spirometry

ATS '94: "Standardization of Spirometry: 1994 Update", American J. Respiratory Critical Care Medicine, Vol. 152, 1107-1136; 1995

ERS '93: "Standardised Lung Function Testing: Official Statement of the European Respiratory Society", The European Respiratory Journal Volume 6, Supplement 16, March "

Lung function", J.E. Cotes, Blackwell scientific publications

"Guidelines for Clinical Exercises Testing Laboratories", I.L. Pina, G.J. Balady, P. Hanson, A.J. Labovitz, D.W. Madonna, J. Myers. American Heart Association. 1995; 91, 912.

Sub-maximal testing

["Cardiorespiratory Assessment of Apparently Healthy Populations", Timothy R. McConnell, in ACSM's Resource Manual for Guidelines for Exercise Testing and Prescription, 4th Edition, pp. 361-366]

[Franklin BA, ed. ACSM's Guidelines for Exercise Testing and Prescription, 6th Edition Philadelphia: Williams&Wilkins, 2000:22-29]